



DLM3000

Enhanced Productivity in a Compact Instrument

DLM3000 Series Mixed Signal Oscilloscope

Precision Making

Bulletin DLM3000-01EN

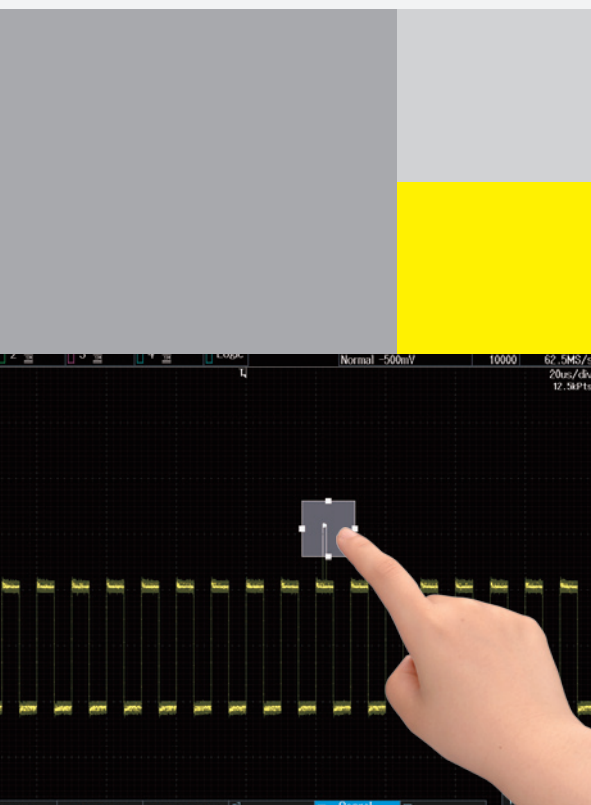

Productivity at your fingertips

The new DLM3000 builds on Yokogawa's oscilloscope legacy with new features focusing on quality, flexibility and usability to increase our users' productivity and meet the advanced needs of today's mechatronics designs.

Integrating the latest in touchscreen operation, solid-state storage, and high speed signal processing, the DLM3000 enhances productivity by providing clean signals, extensive processing, and ease of operation.

Quality – Yokogawa is committed to measurement quality, and the DLM3000 features lower residual noise, extensive voltage ranges and a variety of real-time low pass filters to ensure the fidelity of your signals.

Flexibility – Channel count and memory depth options combined with optional Power Math and serial bus features including major automotive buses ensures an oscilloscope can be configured for a variety of needs.

Usability – The combination of a touchscreen with a traditional panel of oscilloscope controls allows users to seamlessly transition, while communication and storage options make it easy to access large data sets.

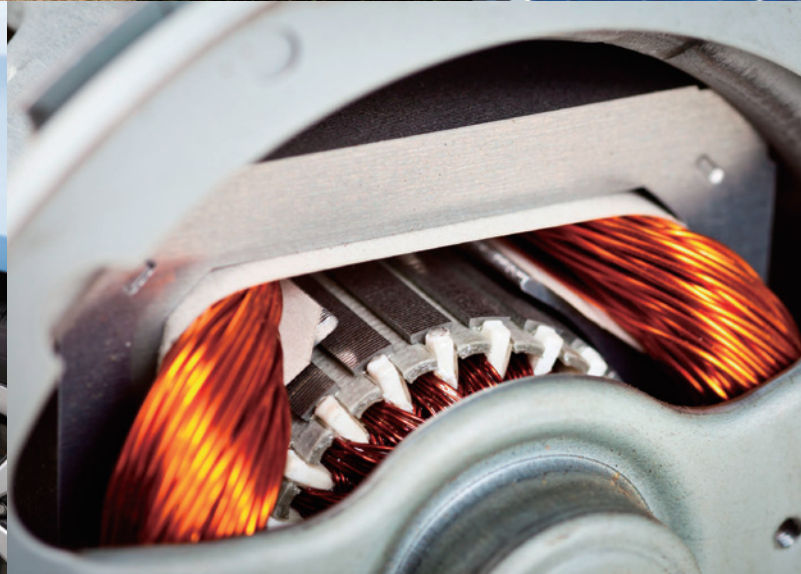

Compact & intuitive operation

Easy-to-Use & Easy-to-See Portrait design

Easy to use portrait design

The large display of a DLM3000 is located above the controls; this enables it to be nearer the eyes of the user and keeps the footprint on the bench to a minimum.

The intuitive controls are laid out so that a user can see at a glance what channels and features are switched-on and quickly make the measurements that are needed.

Easy to configure 8.4 inch display

Users can automatically or manually split the display to separate individual channel waveforms while maintaining their full resolution and dynamic range. It is therefore easy to see the details of all signals regardless of the number of channels in use. The portrait format saves space on the desk or test bench. The DLM3000 is “a compact personal oscilloscope” designed for easy viewing and ease of use.

Intuitive operation with capacitive touchscreen

Touch system user interface provides intuitive operation. Cursor, zoom box, waveform display area, and more can be set quickly by familiar drag and pinch operations.

Conventional buttons and keys are within easy reach so users have the benefits of both control styles.

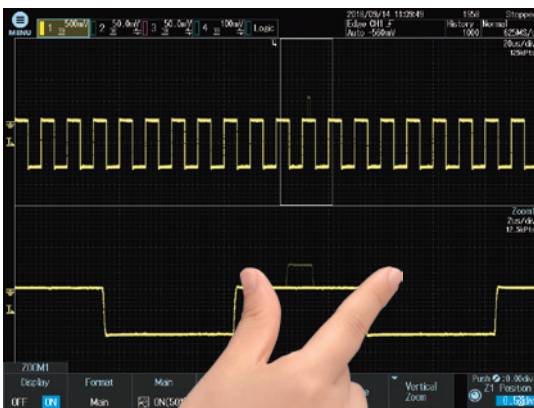

Changing zoom ratio

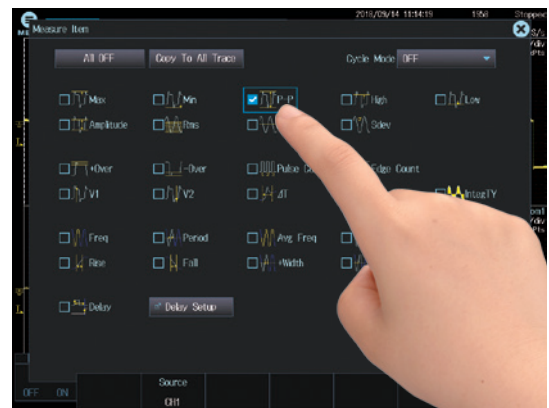

Selecting waveform parameter items

DLM3000

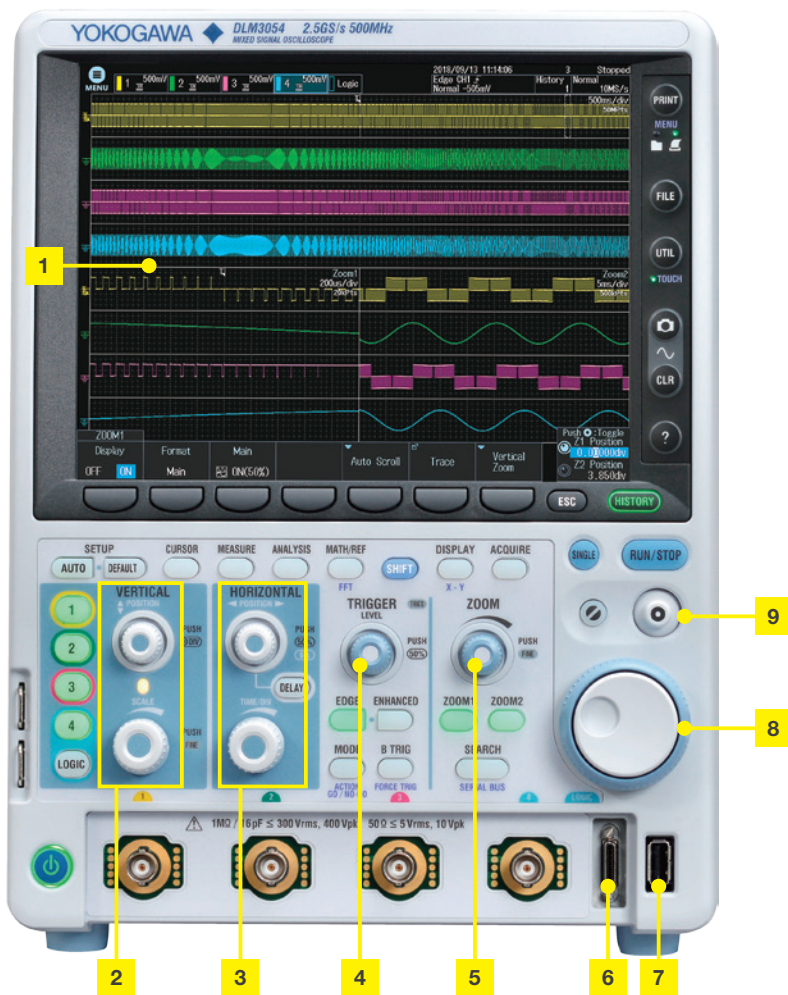

- 1 8.4-inch XGA LCD & Capacitive touchscreen
- 2 Vertical Position and Scale Knob
- 3 Horizontal Position and Scale Knob
- 4 Trigger Control Keys and Level Knob
- 5 Dedicated Zoom Keys
- 6 Logic input connector
- 7 USB peripheral connection terminal
- 8 Jog Shuttle and Rotary Knob
- 9 Four-Direction Selector Button
Select key moves the cursor up/down/left/right



Large screen in a compact body

Footprint is approximately 2/3 the size of an A4 size paper (depth of approximately 200 mm)

Best-in-class long memory

Large capacity memory up to 500 Mpoints

Long memory is necessary to maintain high speed sample rates during long-term measurements.

[Basic Formula] Measuring time = Memory length/Sample rate

If 500 Mpoints (Memory expansion option /M2) is installed, up to 0.2 seconds waveform can be captured even at 2.5 GS/s sample rate while taking 2-ch Single Mode measurements.

Relationship between measuring time and sample rate in 500 Mpoint

Sample rate	Maximum measuring time
2.5 GS/s	0.2 s
250 MS/s	2 s
25 MS/s	20 s
2.5 MS/s	200 s
250 kS/s	2000 s
100 kS/s	5000 s

More memory is needed to use higher sample rates and capture the most accurate waveform representation.

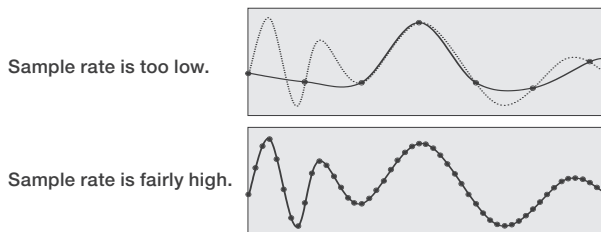

Waveform of 500 Mpoints can be magnified up to × 20000000.



Detailed waveform measured for 20 seconds are shown in 20 milliseconds and 100 microseconds span.

Zoom & search function

Find the most important data rapidly using two independent zoom locations and a variety of search functions.

Zoom two locations simultaneously

Because the two zoom locations can be set individually, you can display two events side-by-side, ideal for finding cause-and-effect relationships. Also, Use Auto Scroll to sweep the zoom window across the waveforms automatically. With Auto Scroll you can choose forward, backward, fast-forward, scroll speed, and other control options.

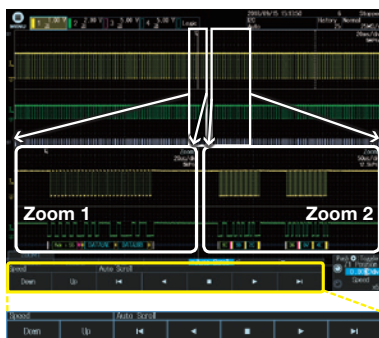

Auto Scroll menu

Zoom Search function

Use several search criteria to automatically find and zoom into features in the waveform for further inspection. The locations of the found waveforms are marked on screen (▼shows the current location).

• Waveform search criteria

Edge, pattern, pulse width, time out, serial bus (only on models with the serial bus analysis option)

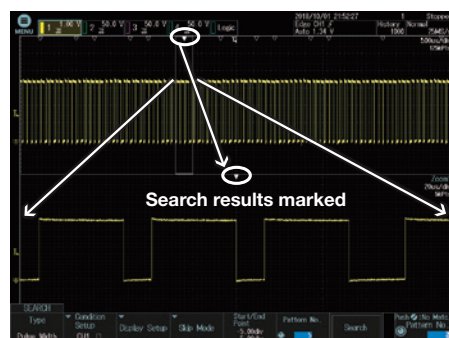

Waveform search using edge criterion

Original History function

Automatically save previously captured waveforms

You can replay waveforms later on, so you'll never miss an abnormal waveform

With the DLM3000 series, up to 100000 previously captured waveforms can be saved in the acquisition memory. With the History function, you can display just one or all of the previously captured waveforms (history waveforms) on screen. You can also perform cursor measurement, computation, and other operations on history waveforms. Using the History function, you can analyze rarely-occurring abnormal signals even when an appropriate trigger condition is hard to find because its waveform shapes are not constant.

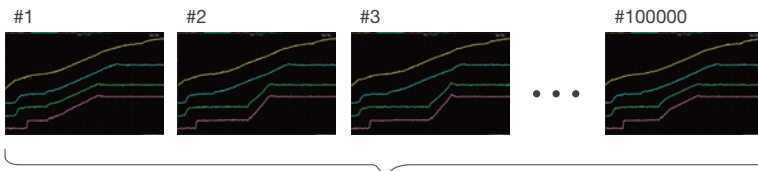

View individual captures to identify the relationship between channels at a specified moment in time.

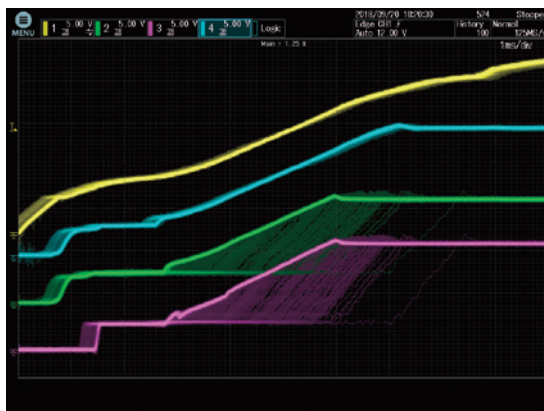

All waveform display mode

Extract abnormal waveform

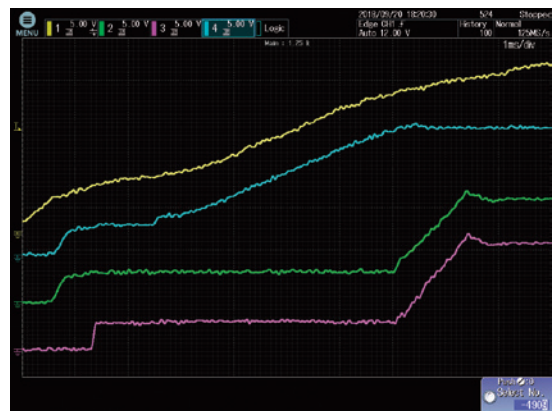

One waveform display mode

History search function

Various search methods are available to search up to 100,000 waveforms for events meeting your custom requirements.

Example of specified waveform search

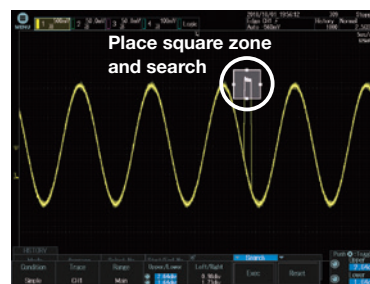

Searching for waveforms that pass through or do not pass through a rectangular zone placed on screen.

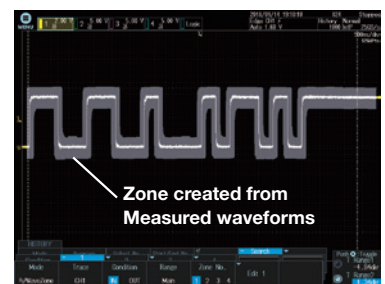

Searching for waveforms in zones created by moving measured waveforms up/down/left/right.

Replay function

You can automatically play back, pause, fast forward, and rewind waveform history record.

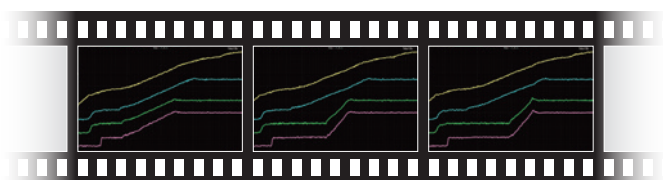

Large selection of triggers and filters

Trigger function captures combined analog/digital complex waveforms

The DLM3000 series comes with a variety of easy-to-configure triggers combining analog and logic inputs such as edge, enhanced, and B triggers. By using a digital trigger system, trigger errors are minimized.

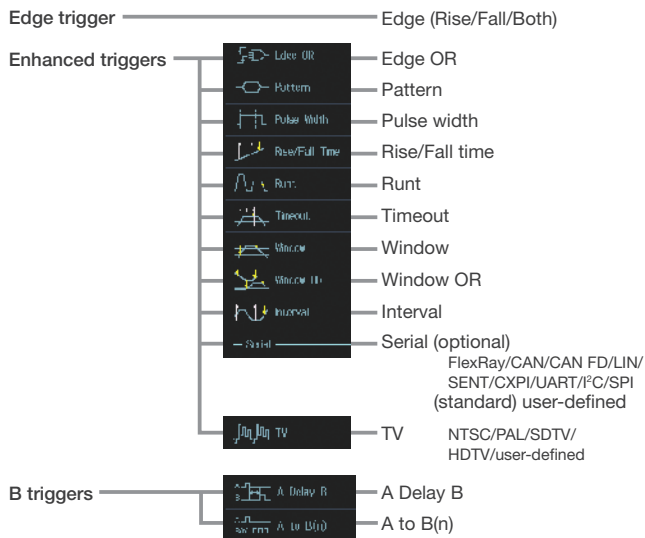

Trigger function examples

A to B(n) trigger

Example: Trigger on the 7th edge of signal on B. This is effective for measurements with shifted timing, such as non-standard video signal vertical/horizontal periods or motor reference position pulses and drive pulses.

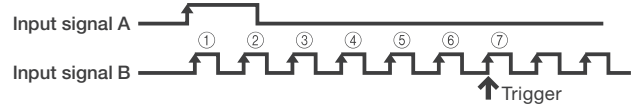

Serial pattern trigger (user defined)

Example: Trigger on an arbitrarily set pattern of up to 128 bits. This is effective for detecting ID/Data and other portions of proprietary communication formats.

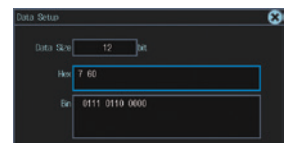

Pattern configuration screen

Real time filter with optimum noise reduction supports a wide range of frequencies (from 8 kHz to 200 MHz)

The DLM3000 series has two types of filters: one processed at the input circuit and one based on MATH functions. These filters are effective for rejecting unwanted signals, allowing observation of only the desired bandwidths.

Real time filters

Each channel has 14 low pass filters available from 8 kHz to 200 MHz. Waveforms are filtered previous to storage in memory.

Cutoff frequencies: 200 MHz, 100 MHz, 20 MHz, 10 MHz, 5 MHz, 2 MHz, 1 MHz, 500 kHz, 250 kHz, 125 kHz, 62.5 kHz, 32 kHz, 16 kHz, and 8 kHz

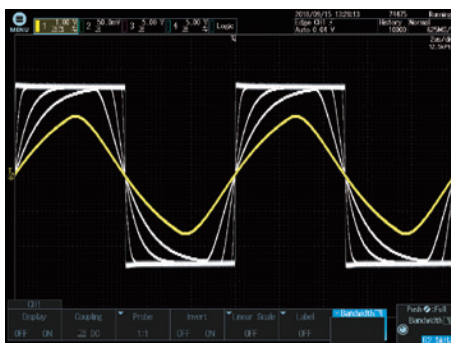

Processing with built-in filters

Computed digital filters

The input waveform can be filtered using an IIR filter, which is a MATH function. Filtered waveforms can be displayed at the same time as the input waveform for comparison. You can select low pass or high pass filters.

Cutoff frequency setting range: 0.01 Hz to 500 MHz

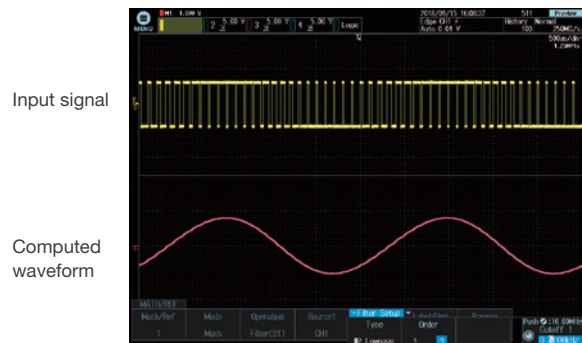

Filtering of a PWM waveform using computation

Features designed for productivity

Displays trends of peak-to-peak or pulse width per cycle

Measure function and statistics

Twenty-nine waveform parameter measurements are included. Automated measurement of up to 30 simultaneous measurements is available. Statistical values can also be measured continuously, cycle-by-cycle or using history memory. In addition, cycle-by-cycle parameter measurement is possible to calculate fluctuations of a captured waveform.

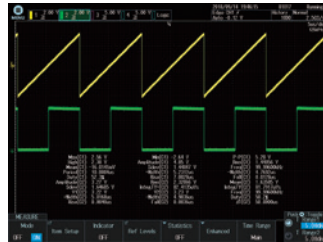

Trend and histogram displays

Waveform parameters such as period, pulse width, and amplitude can be measured repeatedly and displayed in graphs. In a single screen you can observe period-by-period fluctuations, compute amplitudes every screen using multiple waveforms, and display amplitudes as trends. You can also display histograms referencing the voltage or time axis using values from repeated automated measurement of waveform parameters.



Trend display of waveform parameters
Histogram display using the time axis

Measures voltage/time differences automatically

Cursor Measurement

Cursors can be placed on the displayed waveform from signal data, and various measurement values at the intersection of the cursor and waveform can be displayed. There are five types of cursor; ΔT , ΔV , $\Delta T \& \Delta V$, Marker, Degree Cursor.

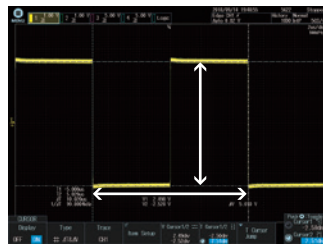

Simultaneous level and time difference measurement with the ΔT & ΔV cursor

Analyzes frequency spectra

FFT analysis

Up to 2 FFT analyses can be performed simultaneously. FFT can be performed on computed waveforms in addition to the actual waveforms on CH1 to CH4. Analysis can be useful for filtering, rotating machinery and other phenomena.

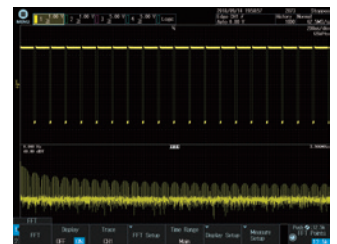

FFT analysis

Keeps waveforms with one push

Snapshot

By pressing the "Snapshot" key to the lower right of the screen, you can freeze a white trace of the currently displayed waveform on the screen. You can press the key repeatedly and conveniently leave traces for comparing multiple waveforms. Also, snapshot data recorded on screen can be saved or loaded as files, and can be recalled for use as reference waveforms when making comparisons.

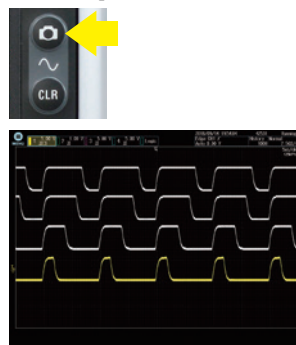

Using snapshots (white waveforms)

Displays stored files in thumbnail format

Thumbnails of saved files

Display thumbnails of saved waveforms, waveform images, and Wave Zone files for easier browsing, copying or deleting. A full-size view shows even more details.



Thumbnail can be viewed full-size



Thumbnails of saved files

Has a GO/NO-GO function

Action on trigger

GO/NO-GO automates pass or fail determination for trigger conditions, waveforms, measured parameters, and other criteria. Actions automate buzzer sounds, file saving, or email notification. Waveforms in which an abnormality occurred can be saved for confirmation and analysis of the phenomena at a later time.

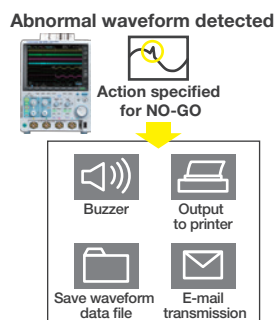

Can check functions with graphical online help

Get help without having to find the user manual. Pressing the "?" key opens detailed graphical explanations of the oscilloscope's functions.

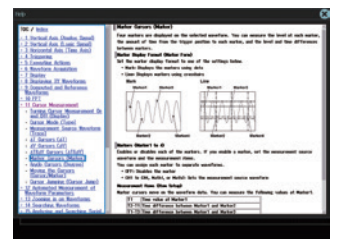

Application-specific analysis options

Serial analysis function options (/F01 to /F05)

UART (RS232)/I²C/SPI/CAN/CAN FD/LIN/FlexRay/SENT/CXPI

Serial bus communication is ubiquitous in all kinds of applications including automotive applications. These buses are adopted everywhere from brake systems to car navigation systems. Communication between electronics control units (ECU's), sensors and actuators is especially important to ensure proper vehicle performance.

In addition to verifying the digital logic of the protocol, developing and verifying these systems also requires analog physical-layer verification of waveform quality, noise, and simultaneous measurement of sensors and actuator signals. The DLM3000 with the serial bus decode functions can display decoded bus data and physical layer waveforms simultaneously, perfect for validation and troubleshooting.

Unique auto setup

Serial bus analysis typically requires numerous settings such as bit rate, voltage threshold, logic polarity, sampling point and trigger condition. These complicated settings can make it difficult to capture data and require long setup phases.

Yokogawa's proprietary auto setup function automatically analyzes the input signal and complex parameters such as bit rate and threshold level, selecting the optimal settings in seconds. This feature not only saves time but is also a powerful debugging feature when the bit rate and other parameters are unknown.

Simultaneous analysis of up to 4 buses

Perform high-speed simultaneous analysis on up to four different serial buses operating at different speeds. Extensive search capabilities enhance the usability, allowing the user to find specific data in the very long memory. The dual-zoom facility means that different buses can be viewed and debugged alongside each other.



Serial bus auto setup



Four bus decode and list display

User defined math option (/G2) Power supply analysis option (/G3)

Create arbitrary calculations using a suite of operations such as arithmetic, trigonometric, pulse width and more. Dedicated power supply analysis options are available for switching loss, I²t, SOA analysis, harmonic analysis of power supply, and other power parameter measurement (4 ch models only) .

Switching loss analysis

Calculate switching loss $[V(t) \times i(t)]$ over long test cycles utilizing the long built-in memory. A wide variety of switching loss analyses are supported, including turn-on/off loss calculation, loss including continuity loss, and loss over long cycles of 50 Hz/60 Hz power line.

Power parameter measurement

Measure power parameters automatically for up to two pairs of voltage and current waveforms, such as active power, apparent power, power factor, and more. Cycle statistics and history statistics can also be calculated.

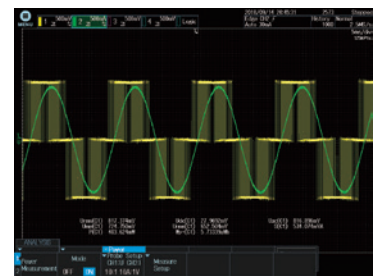

Analog/logic simultaneous measurement

Flexible MSO input

Four channels is not sufficient to view the functioning of digital control circuits. The DLM3000 series converts 4 ch of analog input to 8-bit logic, and functions as a 3 ch analog + 8-bit logic MSO (mixed signal oscilloscope).

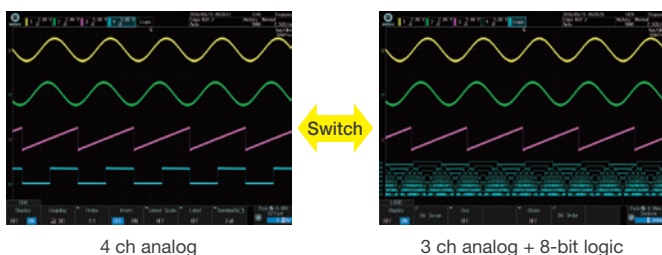

The performance of up to 11 inputs by converting to logic

Using logic input, up to 11 input signals can be observed simultaneously as 3 ch of analog and 8-bit logic. It is not only possible to use logic input for observation of data and control signals, or as a trigger source, but also for logic input analysis of I²C, SPI and some other serial busses.

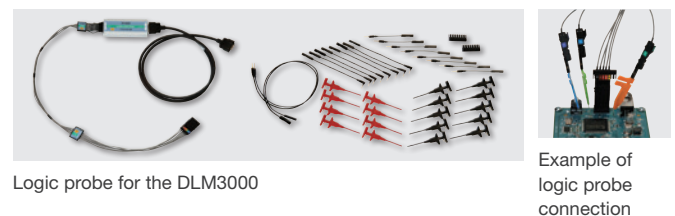

Wide range of interfaces and software

Increase work efficiency by using PC

The totally new CPU platform of the DLM3000 is equipped with Gigabit Ethernet and USB 3.0^{*1} as standard communication interfaces, handling data faster than ever.

For example, DLM3000 is 10 times faster at saving to internal storage and about 10 times faster when transferring to a PC.^{*2} Get answers faster, even with large data sets.

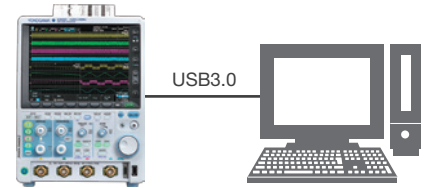

*1 USB function only. USB host function uses USB2.0 communication.

*2 When /C8 option (SSD) is installed for internal storage and USB3.0 mass storage connection is used for transfer. Compare with the conventional model (DLM2000).

Broad Connectivity and Easier Control

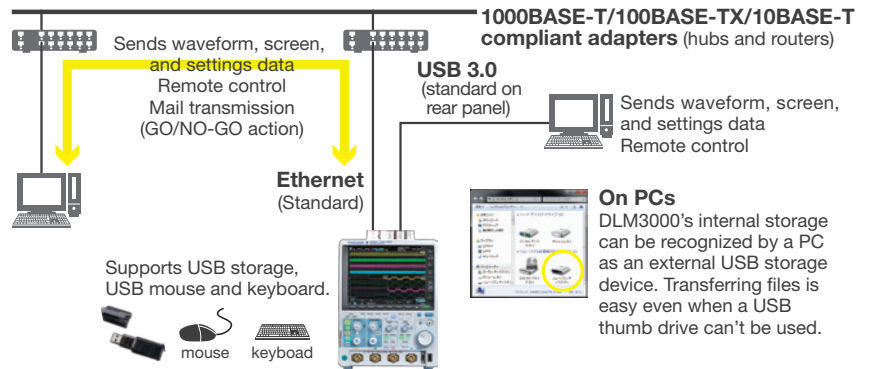
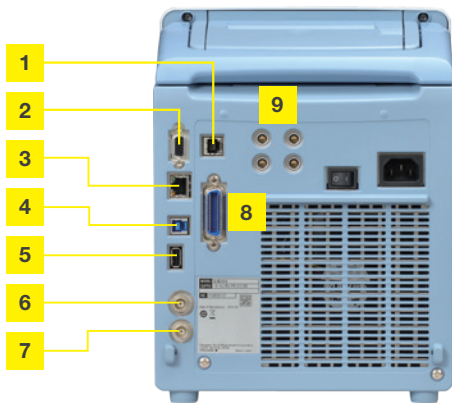

- | | | |
|--|---|---|
| 1 GO/NO-GO output terminal (optional) | 4 USB-PC connection terminal | 7 Trigger output |
| 2 RGB video signal output terminal | 5 USB peripheral connection terminal | 8 GP-IB connection terminal (optional) |
| 3 Ethernet | 6 External trigger input | 9 Probe power terminal (optional) |

Software Control

Free Software

Optional Software Trial version available

Off-line waveform display and analysis	XviewerLITE –Basic viewing– Zoom, V-cursor, conversion to CSV format	Xviewer –Advanced Analysis– Advanced and useful functions are supported. Good for precise, off-line waveform analysis. <ul style="list-style-type: none"> • Waveform observation and analysis • Cursor, Parametric Measure • Statistical Analysis • Multiple file display • Advanced waveform operations • Comment, marking, printing and making report • Optional Math computation feature • Remote monitor • Instruments communication function • Transferring waveform & image files
Waveform monitoring on a PC	XWirepuller Remote monitor and operation Transferring image files	
Data transfer to a PC	Control library “TMCTL” For Visual Studio	
Command control Custom software development	DL-Term Interactive tool LabVIEW instrument driver ^{*1 *3} MATLAB ^{*2 *3} WDF Access ToolBox Transfer data file to MATLAB	

*1: Program development environment provided by National Instruments (NI)
 *2: MathWorks's product.
 *3: DLM3000 will be supported soon.

Specifications

Models			
Model name	Frequency bandwidth	Input terminal	Max. sample rate
DLM3022	200 MHz	2 analog channels	2.5 GS/s
DLM3032	350 MHz		
DLM3052	500 MHz		
DLM3024	200 MHz	4 analog channels / 3 analog channels + 8 bit logic	
DLM3034	350 MHz		
DLM3054	500 MHz		

Analog Signal input				
Input channels	DLM30x2: CH1, CH2			
Analog input	DLM30x4: CH1 to CH4 (CH1 to CH3 when using logic input)			
Input coupling setting	AC 1 M Ω , DC 1 M Ω , DC 50 Ω			
Input impedance	Analog input			
	1 M Ω	$\pm 1.0\%$, approximately 16 pF		
	50 Ω	$\pm 1.0\%$ (VSWR 1.4 or less, DC to 500 MHz)		
Voltage axis sensitivity setting range	1 M Ω	500 μ V/div to 10 V/div (steps of 1-2-5)		
	50 Ω	500 μ V/div to 1 V/div (steps of 1-2-5)		
Max. input voltage	1 M Ω	Must not exceed 300 Vrms or 400 Vpeak		
	50 Ω	Must not exceed 5 Vrms or 10 Vpeak		
Max. DC offset setting range	1 M Ω	500 μ V/div to 50 mV/div	± 1 V	
		100 mV/div to 500 mV/div	± 10 V	
		1 V/div to 10 V/div	± 100 V	
	50 Ω	500 μ V/div to 50 mV/div	± 1 V	
		100 mV/div to 1 mV/div	± 5 V	
Vertical-axis (voltage-axis) DC accuracy ¹	500 μ V/div	$\pm(3.0\%$ of 8 div + offset voltage accuracy)		
	1 mV/div to 10 V/div	$\pm(1.5\%$ of 8 div + offset voltage accuracy)		
Offset voltage accuracy ¹	500 μ V to 50 mV/div	$\pm(1\%$ of setting + 0.2 mV)		
	100 mV to 500 mV/div	$\pm(1\%$ of setting + 2 mV)		
	1 V to 10 V/div	$\pm(1\%$ of setting + 20 mV)		
Frequency characteristics (-3 dB attenuation when inputting a sine wave of amplitude ± 3 div) ^{1,2}		DLM302x	DLM303x	
			DLM305x	
1 M Ω (when using attached 10:1 passive probe)	20 mV to 100 V/div	200 MHz	350 MHz	
	10 mV/div	200 MHz	350 MHz	
	5 mV/div	200 MHz	200 MHz	
50 Ω	2 mV to 10 V/div	200 MHz	350 MHz	
	1 mV/div	200 MHz	350 MHz	
	500 μ V/div	200 MHz	200 MHz	
Isolation between channels	Maximum bandwidth: -34 dB (typical value)			
Residual noise level ³	The larger of 0.2 mVrms or 0.05 div rms (typical value)			
A/D resolution	8 bit (25 LSB/div) Max. 12 bit (in High Resolution mode)			
Bandwidth limit	FULL, 200 MHz, 100 MHz, 20 MHz, 10 MHz, 5 MHz, 2 MHz, 1 MHz, 500 kHz, 250 kHz, 125 kHz, 62.5 kHz, 32 kHz, 16 kHz, 8 kHz (can be set for each channel)			
Maximum sample rate	Real time sampling mode	2.5 GS/s		
	Repetitive sampling mode	250 GS/s		
Maximum record length (Points)		Repeat	Single (when odd ch only)	
	2 ch model	12.5 M	50 M (125 M)	
	4 ch model	12.5 M	50 M (125 M)	
		/M1	25 M	125 M (250 M)
		/M2	50 M	250 M (500 M)
Ch-to-Ch deskew	± 1 μ s			
Time axis setting range	1 ns/div to 500 s/div (steps of 1-2-5)			
Time base accuracy ¹	$\pm 0.002\%$			
Max. acquisition rate	Approx. 400000 waveform/s (when 1 ch display is ON and Dot Connect is set to OFF.)			
Dead time in N Single mode	Approx. 0.9 μ s			

Logic Signal Input (4 ch model only)	
Number of inputs	8 bit (excl. 4 ch input and logic input)
Maximum toggle frequency ¹	Model 701988: 100 MHz, Model 701989: 250 MHz
Compatible probes	701988, 701989 (8 bit input)
Min. input voltage	701988: 500 mVp-p, 701989: 300 mVp-p
Input range	Model 701988: ± 40 V Model 701989: threshold ± 6 V
Max. nondestructive input voltage	Model 701988: ± 42 V (DC + ACpeak) or 29 Vrms Model 701989: ± 40 V (DC + ACpeak) or 28 Vrms
Threshold level setting range	Model 701988: ± 40 V (setting resolution of 0.05 V) Model 701989: ± 6 V (setting resolution of 0.05 V)

Input impedance	701988: Approx. 1 M Ω /approx. 10 pF, 701989: Approx. 100 k Ω /approx. 3 pF	
Maximum sampling rate	1.25 GS/s	
Maximum record length (Points)	Repeat	Single
	Standard	12.5 M
	/M1	25 M
	/M2	50 M
		250 M

Triggers		
Trigger modes	Auto, Auto Level, Normal, Single, N-Single, Force trigger	
Trigger type, trigger source	A triggers	
Edge	CH1 to CH4, Logic, EXT, LINE	
Edge OR	CH1 to CH4	
Pulse Width	CH1 to CH4, Logic	
Timeout	CH1 to CH4, Logic	
Pattern	CH1 to CH4, Logic	
Runt	CH1 to CH4	
Rise/Fall Time	CH1 to CH4	
Interval	CH1 to CH4, Logic	
Window	CH1 to CH4	
Window OR	CH1 to CH4	
TV	CH1 to CH4	
Serial Bus	I ² C (optional)	CH1 to CH4, Logic
	SPI (optional)	CH1 to CH4, Logic
	UART (optional)	CH1 to CH4, Logic
	FlexRay (optional)	CH1 to CH4
	CAN (optional)	CH1 to CH4
	CAN FD (optional)	CH1 to CH4
	LIN (optional)	CH1 to CH4
	SENT (optional)	CH1 to CH4, Logic
	CXPI (optional)	CH1 to CH4
	User Define	CH1 to CH4
AB triggers	A Delay B	10 ns to 10 s
	A to B(n)	1 to 10 ⁹
Trigger level setting range	CH1 to CH4	± 4 div from center of screen
Trigger level setting resolution	CH1 to CH4	0.01 div (TV trigger: 0.1 div)
Trigger level accuracy ¹	CH1 to CH4	± 0.04 div

Display	
Display ⁴	8.4-inch TFT color liquid crystal display, 1024 x 768 (XGA)

Functions	
Waveform acquisition modes	Normal, Envelope, Average
High Resolution mode	Max. 12 bit
Sampling modes	Real time, interpolation, repetitive
Accumulation	Select OFF, Intensity (waveform frequency by brightness), or Color (waveform frequency by color) Accumulation time: 100 ms to 100 s, Infinite
Roll mode	Enabled at 100 ms/div to 500 s/div (depending on the record length setting)
Zoom function	Two zooming windows can be set independently (Zoom1, Zoom2)
	Zoom factor $\times 2$ to 2.5 points/10 div (in zoom area)
	Scroll Auto Scroll
	Search functions Edge, Pulse Width, Timeout, Pattern, I ² C (optional), SPI (optional), UART (optional), CAN (optional), CAN FD (optional), LIN (optional), FlexRay (optional), SENT (optional), CXPI (optional), User Define
History memory	Max. data (record length 1.25 k Points, with) /M2: 100000, /M1: 50000, Standard: 20000
	History search Select Rect, Wave, Polygon, or Parameter mode
	Replay function Automatically displays the history waveforms sequentially
	Display Specified or average waveforms
Cursor	Types ΔT , ΔV , ΔT & ΔV , Marker, Degree
Snapshot	Currently displayed waveform can be retained on screen

Computation and Analysis Functions	
Parameter Measurement	Max, Min, P-P, High, Low, Amplitude, Rms, Mean, Sdev, IntegTY+, IntegTY, +Over, -Over, Pulse Count, Edge Count, V1, V2, ΔT , Freq, Period, Avg Freq, Avg Period, Burst, Rise, Fall, +Width, -Width, Duty, Delay
Statistical computation of parameters	Max, Min, Mean, σ , Count
Statistics modes	Continuous, Cycle, History
Trend/Histogram display of wave parameters	Up to 2 trend or histogram display of specified wave parameters

Computations (MATH)	+, -, ×, Filter (Delay, Moving Avg, IIR Lowpass, IIR Highpass), Integ, Count (Edge, Rotary), user defined math (optional)
Computable no. of traces	4 (Math1 to Math4) (2 trace for 2 ch model) (mutually exclusive with REF trace)
Max. computable memory length	Same as the maximum record length
Reference function	Up to 4 traces (REF1 to REF4) of saved waveform data can be displayed and analyzed (mutually exclusive with MATH trace)
Action-on-trigger	Actions: Buzzer, Print, Save, Mail
GO/NO-GO [®]	Modes: Rect, Wave, Polygon, Parameter Actions: Buzzer, Print, Save, Mail
X-Y	Displays XY1, to XY2 and T-Y simultaneously
FFT	Number of points: 1.25 k, 2.5k, 12.5 k, 25 k, 125 k, 250 k, 1.25 M Window functions: Rectangular, Hanning, Flat-Top FFT Types: PS (LS, RS, PSD, CS, TF, CH are available with /G02 option)
Histogram	Displays a histogram of acquired waveforms
User-defined math [®] (/G02 option)	The following operators can be arbitrarily combined in equations: +, -, ×, /, SIN, COS, TAN, ASIN, ACOS, ATAN, INTEG, DIFF, ABS, SQRT, LOG, EXP, LN, BIN, DELAY, P2 (power of 2), PH, DA, MEAN, HLBT, PWHH, PWLL, PWHL, PWXX, FV, DUTYH, DUTYL, FILT1, FILT2 The maximum record length that can be computed is the same as the standard math functions.
Power supply analysis (/G03 option) [®]	
Power analysis	Selectable from 4 analysis types Deskewing between the voltage and current waveforms can be executed automatically.
Switching loss	Measurement of total loss and switching loss, power waveform display, Automatic measurement and statistical analysis of power analysis items (PTurn On, PTurn Off, POn, PTotal, WpTurn On, WpTurn Off, Wp On, WpTotal, Cycle Count)
Safety operation area	SOA analysis by X-Y display, using voltage as X axis, and current as Y axis is possible
Harmonic analysis	Basic comparison is possible with following standard Harmonic emission standard IEC61000-3-2 edition 4.0, EN61000-3-2 (2006), IEC61000-4-7 edition 2
Joule integral	Joule integral (I ²) waveform display, automatic measurement and statistical analysis is possible
Power Measurement	Automated measurement of power parameters for up to two pairs of voltage and current waveforms. Values can be statistically processed and calculated. Measurement parameters Urms, Urm, Udc, Urmn, Uac, U+pk, U-pk, Up-p, Irms, Imn, Idc, Imn, lac, I+pk, I-pk, Ip-p, P, S, Q, Z, λ, Wp, Wp+, Wp-, Abs.Wp, q, q+, q-, Abs.q, Avg Freq (voltage, current)

Common Features of Serial Bus Signal Analysis Functions	
Analysis result display	Decoded information is displayed together with waveforms or in list form.
Auto setup function	A threshold value, time axis scale, voltage axis scale and other bus-specific parameters such as a bit rate and recessive level are automatically detected. Trigger conditions are set based on the detected result and decoded information is displayed. (The type of a bus signal needs to be specified in advance.)
Search function	Search of all waveforms for a position that matches a pattern or condition specified by data information.
Analysis result saving function	Analysis list data can be saved to CSV-format files.

I ² C Bus Signal Analysis Functions (/F01 Option) [®]	
Applicable bus	I ² C bus Bus transfer rate: 3.4 Mbit/s max. Address mode: 7 bit/10 bit SM bus Complies with System Management Bus
Analyzable signals	CH1 to CH4, LOGiC input, or M1 to M4
I ² C trigger modes	Every Start, Address & Data, NON ACK, General Call, Start Byte, HS Mode
Analyzable no. of data	300000 bytes max.
List display items	Analysis no., time from trigger position [Time (ms)], 1st byte address, 2nd byte address, R/W, Data, Presence/absence of ACK, information

SPI Bus Signal Analysis Functions (/F01 Option) [®]	
Trigger types	3 wire, 4 wire After assertion of CS, compares data after arbitrary byte count and triggers.
Analyzable signals	CH1 to CH4, Logic input, M1 to M4
Byte order	MSB, LSB
Analyzable no. of data	300000 bytes max.
List display items	Analysis no., time from trigger position [Time (ms)], Data 1, Data 2

UART Signal Analysis Functions (/F01 Option) [®]	
Bit rate	115200 bps, 57600 bps, 38400 bps, 19200 bps, 9600 bps, 4800 bps, 2400 bps, 1200 bps, User Define (an arbitrary bit rate from 1 k to 10 Mbps with resolution of 100 bps)
Analyzable signals	CH1 to CH4, LOGiC input, or M1 to M4
Data format	Select a data format from the following 8 bit (Non Parity), 7 bit Data + Parity, 8 bit + Parity
UART trigger modes	Every Data, Data, Error
Analyzable no. of data	300000 bytes max.
List display items	Analysis no., time from trigger position [Time (ms)], Data (Bin, Hex) display, ASCII display, Information.

CAN Bus Signal Analysis Functions (/F02 Option) [®]	
Applicable bus	CAN version 2.0A/B, Hi-Speed CAN (ISO11898), Low-Speed CAN (ISO11519-2)
Analyzable signals	CH1 to CH4, M1 to M4
Bit rate	1 Mbps, 500 kbps, 250 kbps, 125 kbps, 83.3 kbps, 33.3 kbps, User Define (an arbitrary bit rate from 10 kbps to 1 Mbps with resolution of 100 bps)
CAN bus trigger modes	SOF, ID/Data, ID OR, Error, Message and signal (enabled when loading physical values/symbol definitions)
Analyzable no. of frames	100000 frames max.
List display items	Analysis no., time from trigger position [Time (ms)], Frame type, ID, DLC, Data, CRC, presence/absence of Ack, Information
Auxiliary analysis functions	Field jump functions

CAN FD Bus Signal Analysis Functions (/F02 Option) [®]	
Applicable bus	CAN FD (ISO 11898-1:2015 and non-ISO)
Analyzable signals	CH1 to CH4, M1 to M4
Bit rate	Arbitration 1 Mbps, 500 kbps, 250 kbps, User Define (an arbitrary bit rate from 20 kbps to 1 Mbps with resolution of 100 bps) Data 8 Mbps, 5 Mbps, 4 Mbps, 2 Mbps, 1 Mbps, 500 kbps, User Define (an arbitrary bit rate from 250 kbps to 10 Mbps with resolution of 100 bps)
CAN FD bus trigger modes	SOF, ID, ID OR, Error Frame, Message (enabled when loading physical values/symbol definitions)
Analyzable no. of frames	50000 frames max.
List display items	Analysis no., time from trigger position [Time (ms)], Frame type, ID, DLC, Data, CRC, presence/absence of Ack, Information
Auxiliary analysis functions	Field jump functions

LIN Bus Signal Analysis Functions (/F02 Option) [®]	
Applicable bus	LIN Rev. 1.3, 2.0, 2.1
Analyzable signals	CH1 to CH4, M1 to M4
Bit rate	19.2 kbps, 9.6 kbps, 4.8 kbps, 2.4 kbps, 1.2 kbps, User Define (an arbitrary bit rate from 1 kbps to 20 kbps with resolution of 10 bps)
LIN bus trigger modes	Break Synch, ID/Data, ID OR, Error
Analyzable no. of frames	100000 frames max.
List display items	Analysis no., time from trigger position [Time (ms)], ID, ID-Field, Data, Checksum, Information
Auxiliary analysis functions	Field jump functions

FlexRay Bus Signal Analysis Functions (/F03 Option) [®]	
Applicable bus	FlexRay Protocol Version 2.1
Analyzable signals	CH1 to CH4, M1 to M4
Bit rate	10 Mbps, 5 Mbps, 2.5 Mbps
FlexRay bus trigger modes	Frame Start, Error, ID/Data, ID OR
Analyzable no. of frames	5000 frames max.
List display items	Analysis no., time from trigger position [Time (ms)], Segment (Static or Dynamic), Indicator, FrameID, Payload length, Cycle count, Data, Information

SENT Signal Analysis Functions (/F04 Option) [®]	
Applicable standard	J2716 APR2016 and older
Analyzable signals	CH1 to CH4, logic input, or M1 to M4
Clock period	1 μs to 100 μs with resolution of 0.01 μs
Data type	Fast channel Nibbles/User Defined Slow channel Short/Enhanced
SENT trigger modes	Every Fast CH, Fast CH Status & Communication, Fast CH Data, Every Slow CH, Slow CH ID/Data, Error
Analyzable no. of frames	10000 frames max.
List display items	Fast channel Analysis no., time from trigger position [Time (ms)], Sync/Cal period, Tick, Status & Comm, Data, CRC, frame length, Information Slow channel Analysis no., time from trigger position [Time (ms)], ID, Data, CRC, information

Auxiliary analysis functions	Trend functions (up to 4 trend waveforms)
------------------------------	---

CXPI Bus Signal Analysis Functions (/F05 Option)⁶

Applicable bus	CXPI JASO D 015-3:2015
Analyzable signals	CH1 to CH4, M1 to M4
Bit rate	19.2 kbps, 9.6 kbps, 4.8 kbps, User Define (an arbitrary bit rate from 4 kbps to 50 kbps with resolution of 10 bps)
Analyzable no. of frames	10000 frames max.
List display items	Analysis no., time from trigger position [Time (ms)], ID, DLC, W/S, CT, Data, CRC, error information, Wakeup/Sleep

GP-IB (/C1 Option)

Electromechanical specifications	Conforms to IEEE std. 488-1978 (JIS C 1901-1987)
Protocol	Conforms to IEEE std. 488.2-1992

Auxiliary Input

Rear panel I/O signal	External trigger input, External trigger output, GO/NO-GO output (/C1 Option), Video output
Probe interface terminal (front panel)	2 terminals (DLM30x2), 4 terminals (DLM30x4)
Probe power terminal (rear panel)	2 terminals (/P2 option), 4 terminals (/P4 option)

Internal Storage (Standard model, /C8 Option)

Capacity	Standard model: Approx. 300 MB, /C8 option: Approx. 60 GB
----------	---

Built-in Printer (/B5 Option)

Built-in printer	112 mm wide, monochrome, thermal
------------------	----------------------------------

USB Peripheral Connection Terminal

Connector	USB type A connector × 2 (front panel × 1, rear panel × 1)
Electromechanical specifications	USB 2.0 compliant
Supported transfer standards	High Speed, Full Speed, Low Speed
Supported devices	USB Printer Class Ver. 1.0 compliant HP (PCL) inkjet printers, USB Mass Storage Class Ver. 1.1 compliant mass storage devices (Usable capacity: 8 TB, Partition format: GPT / MBR, File format: exFAT / FAT 32 / FAT 16) * Please contact your local YOKOGAWA sales office for model names of verified devices

USB-PC Connection Terminal

Connector	USB type B connector × 1
Electromechanical specifications	USB 3.0 compliant
Supported transfer standards	Super Speed, High Speed, Full Speed
Supported class	USBTMC-USB488 (USB Test and Measurement Class Ver. 1.0)

Ethernet

Connector	RJ-45 connector × 1
Transmission methods	Ethernet (1000BASE-T/100BASE-TX/10BASE-T)
Supported services	Server: FTP, VXI-11, Socket Client: FTP, SMTP, SNMP, LPR, DHCP, DNS

General Specifications

Rated supply voltage	100 to 120 VAC/220 to 240 VAC (Automatic switching)
Rated supply frequency	50 Hz/60 Hz
Maximum power consumption	180 VA
External dimensions	226 (W) × 293 (H) × 193 (D) mm (when printer cover is closed, excluding protrusions)
Weight	Approx. 4.2 kg, With no options
Operating temperature range	5°C to 40°C

*1: Measured under standard operating conditions after a 30-minute warm-up followed by calibration.
Standard operating conditions: Ambient temperature: 23°C±5°C, Ambient humidity: 55±10% RH
Error in supply voltage and frequency: Within 1% of rating

*2: Value in the case of repetitive phenomenon. The frequency bandwidth of a single-shot phenomenon is the smaller of the two values, DC to sampling frequency/2.5 or the frequency bandwidth of the repetitive phenomenon.

*3: When the input section is shorted, the acquisition mode is set to Normal, accumulation is OFF, and the probe attenuation is set to 1:1.

*4: The LCD may include a few defective pixels (within 3 ppm over the total number of pixels including RGB).

*5: GO/NO-GO terminal is included in /C1 option.

*6: For 4 ch model only.

External Dimensions

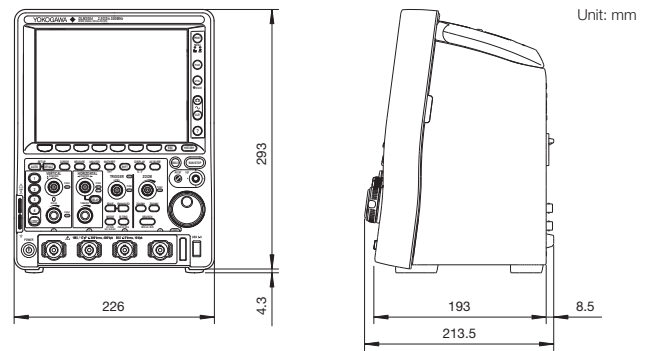

Model and Suffix Codes

Model ¹	Suffix code	Description
DLM3022		Digital Oscilloscope: 2 ch, 200 MHz
DLM3024 ²		Mixed Signal Oscilloscope: 4 ch, 200 MHz
DLM3032		Digital Oscilloscope: 2 ch, 350 MHz
DLM3034 ²		Mixed Signal Oscilloscope: 4 ch, 350 MHz
DLM3052		Digital Oscilloscope: 2 ch, 500 MHz
DLM3054 ²		Mixed Signal Oscilloscope: 4 ch, 500 MHz
Power cord	-D	UL/CSA Standard and PSE compliant
	-F	VDE/Korean Standard
	-Q	British Standard
	-R	Australian Standard
	-H	Chinese Standard
	-N	Brazilian Standard
	-T	Taiwanese Standard
	-B	Indian Standard
	-U	IEC Plug Type B
Language	-HJ	Japanese message and panel
	-HE	English message and panel
	-HC	Chinese message and panel
	-HG	German message and panel
	-HF	French message and panel
	-HK	Korean message and panel
	-HL	Italian message and panel
	-HS	Spanish message and panel
	Option	/LN
/B5		Built-in printer (112 mm)
/M1		Memory expansion option (4 ch model only) During continuous measurement: 25 Mpoints; Single mode: 125 Mpoints/250 Mpoints ³
/M2		Memory expansion option (4 ch model only) During continuous measurement: 50 Mpoints; Single mode: 250 Mpoints/500 Mpoints ³
/P2 ⁴		2 probe power terminals (for 2 ch model)
/P4 ⁴		4 probe power terminals (for 4 ch model)
/C1		GP-IB interface + GO/NO-GO terminal
/C8		Internal storage (60 GB)
/G02		User-defined math function (4 ch model only)
/G03		Power supply analysis function (4 ch model only)
/F01		UART + I ² C + SPI trigger and analysis (4 ch model only)
/F02		CAN + CAN FD + LIN trigger and analysis (4 ch model only)
/F03		FlexRay trigger and analysis (4 ch model only)
/F04		SENT trigger and analysis (4 ch model only)
/F05		CXPI trigger and analysis (4 ch model only)

Standard Main Unit Accessories

Power cord, Passive probe⁵, Protective front cover, Panel sheet⁶, Soft carrying case for probes, Printer roll paper (for /B5 option), User's manuals⁷

- *1: Standard memory capacity: During continuous measurement: 12.5 Mpoints; Single mode: 50 Mpoints/125 Mpoints (when odd channels only)
 *2: Logic probes sold separately. Please order the model 701988/701989 accessory logic probes separately.
 *3: When odd channels only
 *4: Specify this option when using current probes or other differential probes that don't support probe interface.
 *5: 701937, per number of channels.
 *6: Except suffix code "-HE".
 *7: Start guide as the printed material, and User's manual as CD-ROM are included.

Accessory Models

Name	Model	Specification
Logic probe (PBL100)	701988	1 MΩ input resistance, toggle frequency of 100 MHz
Logic probe (PBL250)	701989	100 kΩ input resistance, toggle frequency of 250 MHz
Passive probe ¹	701937	10 MΩ (10:1), 500 MHz, 1.3 m
FET probe ¹	700939	DC to 900 MHz bandwidth, 2.5 MΩ/1.8 pF
100:1 voltage probe	701944	DC to 400 MHz bandwidth, 1.2 m, 1000 Vrms
100:1 voltage probe	701945	DC to 250 MHz bandwidth, 3 m, 1000 Vrms
Differential probe	701920	DC to 500 MHz bandwidth, max. ±12 V
Differential probe	701921	DC to 100 MHz bandwidth, max. ±700 V
Differential probe	701922	DC to 200 MHz bandwidth, max. ±20 V
Differential probe (PBDH1000)	701924	DC to 1 GHz bandwidth, 1MΩ, max. ±25 V
Differential probe	701926	DC to 50 MHz bandwidth, 5000 Vrms/7000 Vpeak
Differential probe (PBDH0150)	701927	DC to 150 MHz bandwidth, max. ±1400 V
Differential probe	700924	DC to 100 MHz bandwidth, max. ±1400 V
Differential probe	700925	DC to 15 MHz bandwidth, max. ±500 V
Current probe ²	701917	DC to 50 MHz bandwidth, 5 Arms, High-sensitivity
Current probe ²	701918	DC to 120 MHz bandwidth, 5 Arms, High-sensitivity
Current probe (PBC050) ²	701929	DC to 50 MHz bandwidth, 30 Arms
Current probe (PBC100) ²	701928	DC to 100 MHz bandwidth, 30 Arms
Current probe ²	701930	DC to 10 MHz bandwidth, 150 Arms
Current probe ²	701931	DC to 2 MHz bandwidth, 500 Arms
Deskew correction signal source	701936	For deskew correction
Go/No-Go Cable	366973	For GO/NO-GO output terminal
Printer roll paper	B9988AE	Lot size is 10 rolls, 10 meters each
Probe stand	701919	Round base, 1 arm
Soft carrying case	701964	With 3 pockets for storage

*1: Please refer to the Probes and Accessories brochure for probe adapters.

*2: Current probes' maximum input current may be limited by the number of probes used at a time.

Accessory Software

Model	Name	Specification
701992-SP01	Xviewer	Standard version
701992-GP01		With MATH functions

Additional Option License for DLM3000^{*1}

Model	Suffix code	Description
709811	-G02	User defined math
	-G03	Power supply analysis function
	-F01	UART + I ² C + SPI trigger and analysis
	-F02	CAN + CAN FD + LIN trigger and analysis
	-F03	FlexRay trigger and analysis
	-F04	SENT trigger and analysis
	-F05	CXPI trigger and analysis

*1: Separately sold license product (customer-installable). (4 ch model only)

NOTICE

- Before operating the product, read the user's manual thoroughly for proper and safe operation.

This is a Class A instrument based on Emission standards EN61326-1 and EN55011, and is designed for an industrial environment. Operation of this equipment in a residential area may cause radio interference, in which case users will be responsible for any interference which they cause.

YOKOGAWA

<https://tmi.yokogawa.com/>

YMI-KS-MI-SE06

YOKOGAWA TEST & MEASUREMENT CORPORATION

Global Sales Dept. /Phone: +81-422-52-6237 E-mail: tm@cs.jp.yokogawa.com
 Facsimile: +81-422-52-6462

YOKOGAWA CORPORATION OF AMERICA

YOKOGAWA EUROPE B.V.

YOKOGAWA SHANGHAI TRADING CO., LTD.

YOKOGAWA ELECTRIC KOREA CO., LTD.

YOKOGAWA ENGINEERING ASIA PTE. LTD.

YOKOGAWA INDIA LTD.

YOKOGAWA ELECTRIC CIS LTD.

YOKOGAWA AMERICA DO SUL LTDA.

YOKOGAWA MIDDLE EAST & AFRICA B.S.C(c)

Phone: +31-88-4641000
 Phone: +86-21-6239-6363
 Phone: +82-2-2628-3810
 Phone: +65-6241-9933
 Phone: +91-80-4158-6396
 Phone: +7-495-737-78-68
 Phone: +55-11-3513-1300
 Phone: +973-17-358100

The contents in this catalog is as of October 2018. Subject to change without notice.

Copyright © 2018, Yokogawa Test & Measurement Corporation

[Ed: 01/b]

Printed in Japan, 810(KP)

E-mail: tmi@us.yokogawa.com

E-mail: tmi@nl.yokogawa.com

E-mail: tech@ysh.com.cn

E-mail: TMI@kr.yokogawa.com

E-mail: TMI@sg.yokogawa.com

E-mail: tmi@in.yokogawa.com

E-mail: info@ru.yokogawa.com

E-mail: tm@br.yokogawa.com

E-mail: help.ymatmi@bh.yokogawa.com

Facsimile: +86-21-6880-4987

Facsimile: +82-2-2628-3899

Facsimile: +65-6241-9919

Facsimile: +91-80-2852-1442

Facsimile: +7-495-737-78-69

Facsimile: +973-17-336100