



# The world's best seller

## WT300E Series Digital Power Meter



**The WT300E series is the enhanced version of Yokogawa's 5<sup>th</sup> generation of compact power meters. The world's best-selling power meter is the instrument of choice for a wide range of applications in production testing, quality assurance and Research & Development.**

**WT300E power meters are easy to use, cost effective and accurate for diverse applications such as the testing of electric devices, the development and evaluation of home appliances and induction cookers, battery and DC driven device testing, and conformance tests on uninterruptable power supplies.**

**The exceptional low power performance of the WT300E and power consumption software enables users to easily test their instruments to Energy Star, SPEC and standby power standards.**

## **The WT300E delivers**

### **Expertise**

The WT300E represents over 30 years of reliability and innovation in the compact power meter segment. With the widest range of quality power measurement solutions, users can be confident that Yokogawa always provides the right solution for their needs

### **Performance**

WT300E power meters offer precision measurements at low cost, thus providing true customer satisfaction.

### **Space**

The small footprint and compact size of the WT300E makes it ideal for ad-hoc bench use and for rack mounting.



WT300E series

**30+ years of Compact Power Meter expertise and reliability.**

- 1915 **YOKOGAWA** founded
- 1979 First Compact Digital Power Meter **2509**
- 1992 **2534/2535**
- 1995 **WT110/WT130**
- 2002 **WT210/WT230**
- 2012 **WT300 series**
- 2015 Latest Compact Digital Power Meter **WT300E series**

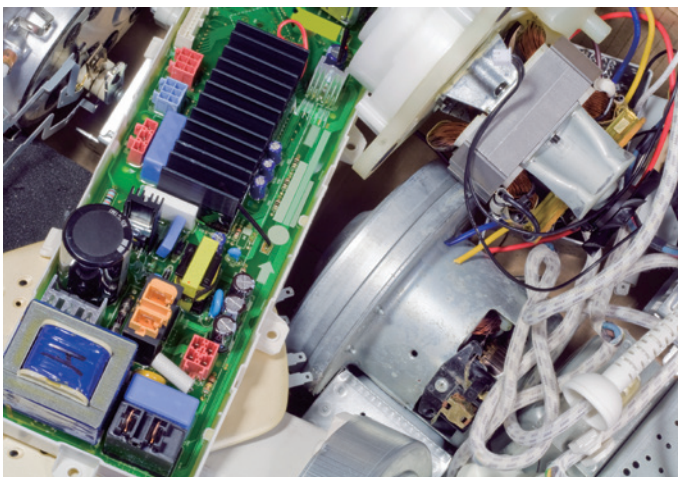



# Features and benefits

## Improvement of basic power accuracy

The WT300E series provides a basic power accuracy of  $\pm 0.15\%$  (50/60 Hz) on all measurement ranges. It is the most accurate power meter in the compact category. The influence at low power factors is twice as good (0.1% of S) than the previous model.

## Wide current ranges

The WT300E series cover broad ranges of current input from a few mA up to 40 A rms. It can measure waveforms which include both AC and DC. Users can use it from the low currents of standby power to the high currents of induction cooking.

### The WT300E series lineup

<b>WT310E series</b>	WT310E: 1 Input element model WT310EH: 1 Input element/High current model
<b>WT330E series</b>	WT332E: 2 Input elements model WT333E: 3 Input elements model

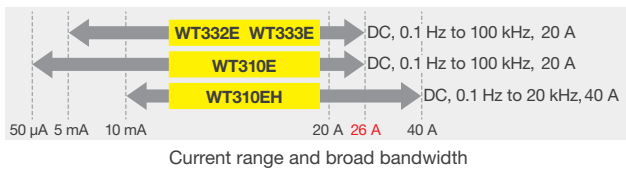

## Fast display and data update rate

The fast display and 100 ms maximum data update rate of the WT300E series offers customers a short tact time in their testing procedures.

Consistent Basic Measurement Accuracy for all input ranges.

## Auto data update rate function for fluctuating input

The WT300E series can chase fluctuating input frequencies like those in motors by changing the data update rate automatically. It can cover from the lowest 0.1 Hz input.

Users can select an "Auto" update rate in addition to the fixed settings in previous models. It can detect cycles of input signal automatically and measure it correctly.

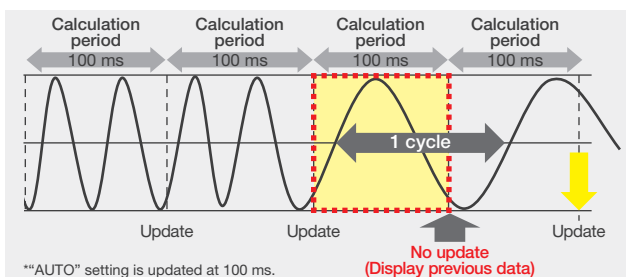

## Auto ranging function available in selected ranges

The auto-range function is used to select/change the range

automatically in specific ranges.

This results in shorter range changing times and thus quicker and more efficient testing.

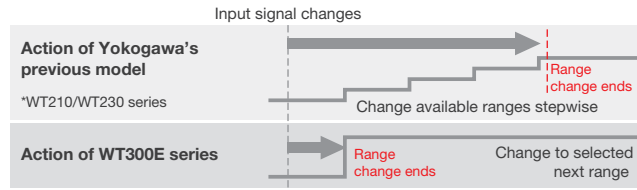
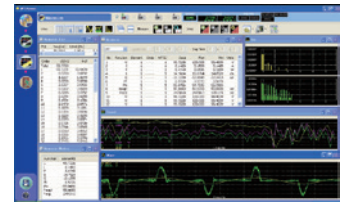

Image of Range skip (configuration) function operation

## High performance and reliability

### Simultaneous measurement of all parameters

The WT300E series can measure all DC and AC parameters. It can also measure harmonics and perform integration simultaneously without changing the measurement mode. The WTViewerFreePlus software is used to monitor



Example of WTViewerFreePlus display

and save all measurement items of up to 200 parameters.

### Convenient measurement functions

- MAX hold function  
The maximum values of RMS/PEAK voltage & current active power, reactive power and apparent power can be held.
- Line filter and frequency filter capability  
These filter functions will cut off unnecessary noise & harmonic components for fundamental waveform measurements.

### Integration measurement auto ranging function

Conventionally, when power meters operate in an integration mode to measure power consumption and standby power, the measuring ranges need to be fixed.

However, if the level of the input exceeds the maximum of the selected range, the results will be incorrect and the test will need to be repeated with higher ranges applied.

The WT300E series has a high speed automatic ranging capability in integration mode which removes this need to repeat the test and integration is continuous and accurate.

This function is not only available for  $\pm Wh$  but also for Ah and DC current.

## The mode of Crest Factor "6A"

When "6A" is chosen as the Crest factor, the maximum rated input of the voltage and current becomes 260% of the range and up to 280% is displayable. When high resolution is required, users can prevent frequent current range changes by using this mode.

# Options and capabilities

## 5 A wide range of communication interfaces such as USB, GP-IB or RS-232 (selectable) and Ethernet (optional)

Users therefore have the flexibility to choose according to their application needs e.g. from production lines to engineering test benches. Users can use WTVIEWERFreePlus software to set up all kinds of measurements. Additionally, the numeric values, waveform display\* and trend graphs of the measurement data can be displayed and saved.

\*Waveform display requires the /G5 Harmonic option

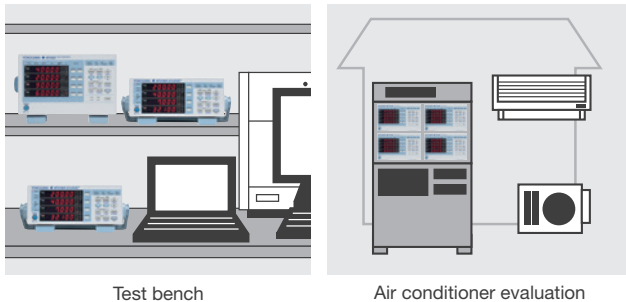

## Connectivity of Modbus/TCP\*<sup>1</sup> with YOKOGAWA's recorders and Ethernet\*<sup>1</sup> with PLC

Measured digital data of the WT series can be acquired by YOKOGAWA's recorder GP10<sup>2,3</sup> and GM<sup>2,3</sup> via Ethernet or Modbus/TCP directly. It is possible to make use of the GA10<sup>2</sup> data logging software.

And also, it can be connected with YOKOGAWA's PLC, FA-M3V<sup>2</sup> by VXI-11 protocol for production fields.

\*<sup>1</sup> /C7 Ethernet option is required.

\*<sup>2</sup> GP10/GM/GA10/FA-M3V are manufactured by Yokogawa Electric Corporation.

\*<sup>3</sup> /E2 and /MC options are required.

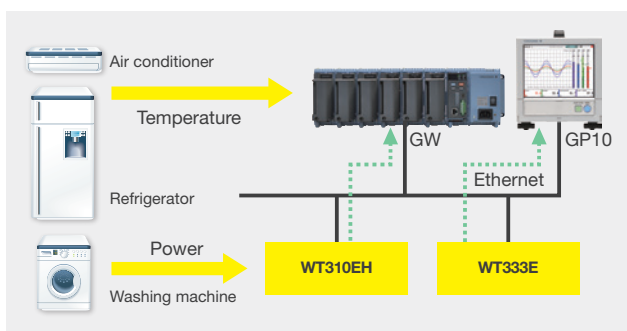

## D/A output for measurement recording

The D/A option is used to output voltage, current, power and other measured data for recording to data loggers ( $\pm 5$  Vdc outputs). (WT310E/WT310EH 4 CH, WT332E/WT333E 12 CH)



## Comparator Function

The WT300E series outputs +5 V, 0 V, or -5 V. To replace the output with a relay contact output, like the WT210/WT230 comparator function, a user can implement their own relay and driving circuit.

## Current sensor input

Users can select either an /EX1 input option (2.5 to 10 V) or an /EX2 (50 mV to 2 V) for measuring large currents using current clamps or current sensors with voltage outputs.

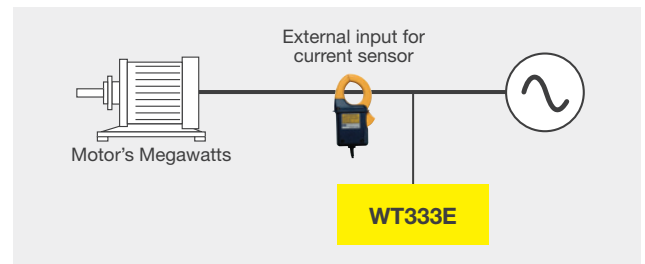

## Automatic zero adjustment

The WT300E series compensates for any drift in the zero level by automatically performing a zero adjustment when the input ranges are changed. This is achieved in less than 100 ms and does not require the wiring to be disconnected.

# Applications

## Production line or QA testing of electric devices

- Compact half rack mount size helps customers build smaller test systems with a better Return on Investment.
- D/A output function and Modbus/TCP\* function for data recording
- Multiple communication interfaces. USB, RS-232 or GP-IB and Ethernet capability.

The simultaneous measurement of power consumption parameters such as U, I, P, frequency, power factor and harmonics for production line or QA testing results in reduced tact times. Thus testing is faster and low cost. The DA output and communication interfaces enable data to be remotely and flexibly captured.

\*"Modbus/TCP" function is supplied with the Ethernet (/C7 option).

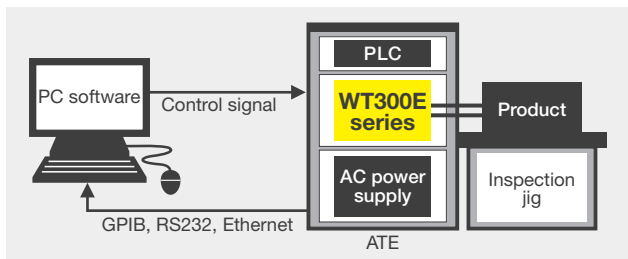

## Development and evaluation tool for home appliances

- 5 mA range helps small current measurement (WT310E)
- Auto ranging function under Integration mode
- Range skip (range configuration) function provides the ability to select the usable ranges in advance. Auto ranging enables the WT300E series to rapidly adapt to changing input conditions.

The range skip function reduces the range change transition period. The WT310E can measure both large and small currents accurately in a single test. This can reduce the total evaluation period or removes the need to use two power meters for the application, rather than one, thereby saving capital cost.

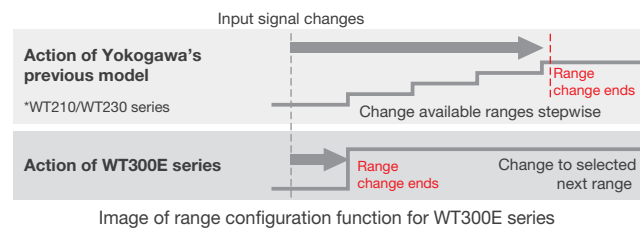

Image of range configuration function for WT300E series

## Testing to international standards, such as IEC62301, Energy Star and SPECpower

- The WT310E has a high measurement resolution of maximum 100  $\mu$ W under the 5 mA range setting.
- Simultaneous measurement of normal power parameters, harmonic components and THD.
- Dynamic input capability of crest factor maximum 300 (Peak value/minimum effective RMS value)
- Free PCM software for IEC62301<sup>\*1</sup> testing

The WT310E together with the power consumption measurement (PCM) software enables users to perform standby power testing according to international standard.

\*1 The IEC62301 E2.0 is a reference standard in the EN50564: 2011 Directive. This software corresponds to a test method of those two standards.

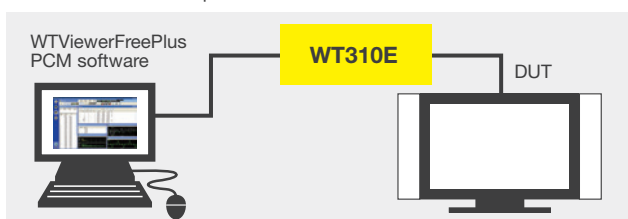

## Evaluation of large current equipment such as induction heaters/cookers

- Direct high current measurement up to 40 Arms without using external current sensors (WT310EH).
- Auto ranging function for Integration mode

The WT310EH allows the direct input of up to 40 Arms without the need to use current clamps or current sensors. This not only provides more precise measurement but also saves on investment costs. It provides wide current ranges of 1 A to 40 A and voltage from 15 V to 600 V.

Users can use it for the evaluation of special waveform driven devices such as IH cookers and heaters.

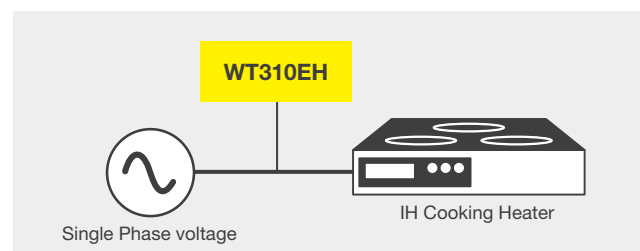

## 7 Automotive—Battery or DC driven device evaluation

- Accurate DC measurement: 0.3% total (WT310EH: 0.5% total)
- Direct high current measurement up to 40 A without any external current sensor (WT310EH).
- Charge/Discharge ( $\pm Wh$ ,  $\pm Ah$ ) energy measurement for batteries

The WT310EH can measure currents up to 40 A directly. This provides a cost effective and accurate method for testing DC driven devices in vehicles without having to use extra sensors.

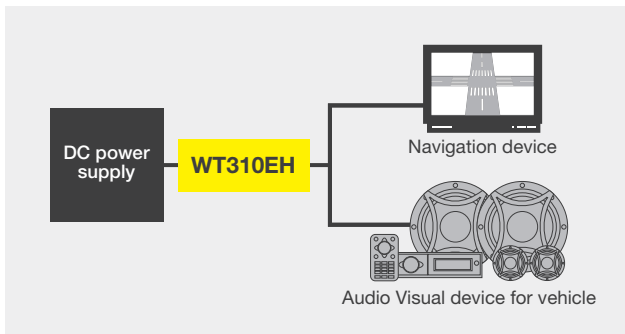

## Evaluation testing of special waveform driven devices and distorted waveforms (including DC component)

- DC, 0.1 Hz to 100 kHz broad bandwidth capability (WT310EH: Up to 20 kHz)
- Average active power measurement under integration mode

The WT300E series has a broad frequency capability of DC and from 0.1 Hz to 100 kHz. It can measure the RMS value of distorted waveforms like square waveforms or special waveform driven devices. The average active power measurement function gives accurate power consumption data for fluctuating power devices such as Intermittent waveform operated devices. Therefore the users can perform accurate distorted waveform measurements without using special mode settings.

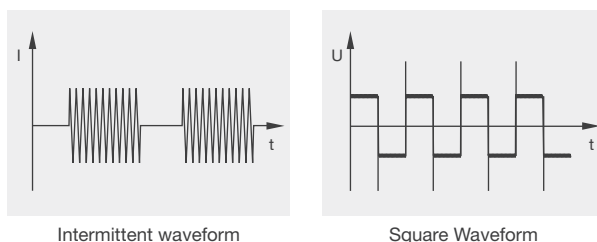

## Duration testing and efficiency measurement for industrial motors and rotating machinery

- Integration measurement for long periods
- Modbus/TCP Protocol for data recording
- DC, 0.1 Hz to 100 kHz broad bandwidth capability (WT310EH: Up to 20 kHz)

The WT300E series provides reliable current integration (Ah) and energy (Wh) measurement for up to 10000 hours (approx. 1 year). The Modbus/TCP communication with /C7 option is used to save and monitor the measurement results up to a maximum of 200 channels. The YOKOGAWA GA10 data gathering software can be used to save data along with other parameters such as temperatures, torque and rotation speed by this Modbus/TCP Protocol.

\*GA10/GP20 are manufactured by Yokogawa Electric Corporation.

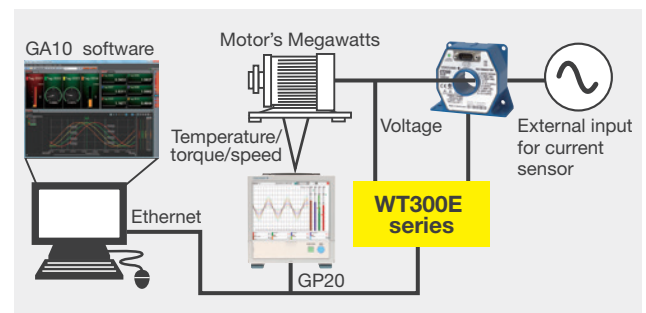

## Conformance and evaluation testing of uninterruptable power supplies (UPS)

- Maximum order setting for THD calculations
- Efficiency measurements using a single power meter
- Average active power measurement under integration mode

The WT300E series enables users to conduct conformity tests according to UPS performance testing standards. The WT300E series is used to measure and calculate input & output levels, the efficiency, frequency and THD. The average active power data also provides accurate values of power consumption. The WT300E series along with the WTVIEWERFreePlus software helps to simultaneously measure all the necessary parameters required to test a UPS thereby reducing the evaluation time.



# Software

## Free PC application software WTViewerFreePlus (included)

The WTViewerFreePlus software can capture measured numeric values, harmonic values and waveform data. The data can be transferred to a PC via a USB, GP-IB/RS-232 or Ethernet communication interface, and it can be displayed\* and saved on the PC.

\*Waveform display requires /G5 Harmonic option.

### Setting Window

As well as using the WT300E series front panel to setup the powermeter, users can use the software to quickly set up their favorite conditions.

It also shows all the setting parameters and the status at a glance. In particular, the range-skip function (range configuration) can be set and the maximum order used for the THD calculation can be specified.



### Measurement Window

The software can display items which cannot be shown on the display of the WT300E series, such as multiple numeric measurement parameters, the harmonics data of each order, bar graphs, trend graphs and voltage & current waveforms. The free software thus adds additional performance to the WT300E series.

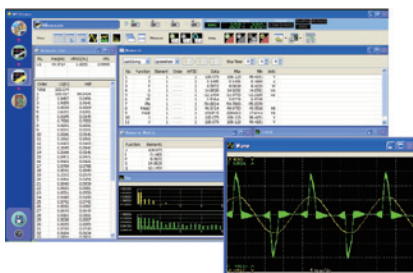

### Multiple units & users support function

New version of WTViewerFreePlus gives the ability to connect up to four WT300E series units (with the same model code). The enables the collection of the measurement data from multiple units.

The WT300E series provides flexibility to users by offering various communication interfaces such as USB, Ethernet, GP-IB and RS-232. With the "Device Search" feature, it allows the WT300E

series to connect to the PC automatically. The software assist the set up of favorite conditions and the measurement of 200 power parameters simultaneously.

\*The simultaneous measurement function might be delayed for up to one update period.

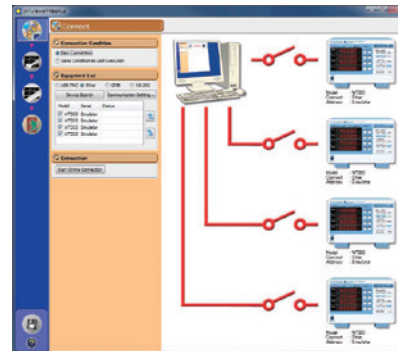

## Power Consumption Measurement Software (Free)

The Power Consumption Measurement Software together with a WT310E (or another WT series instrument) provides a trustworthy power measurement solution for testing the standby and off mode power of household products and office equipment. The solution enables testing to be performed according to the IEC62301 Ed1.0 and Ed2.0 standards which specify the use of special algorithms for determining the power stability in the device under test. The software thus gathers all the required measurement data from the WT310E, which includes not only voltage/current/power/frequency but also the total harmonic distortion (THD) and the crest factor (CF) of the AC power supply. The WT310E need to be equipped with the harmonic option (/G5) and a low distortion power supply must be used.

\*The IEC62301 E2.0 is a reference standard in the EN50564: 2011 Directive. This software corresponds to a test method of those two standards.



Configuring and Establishing a New Connection between the WT310E and a PC



Test Report



## 9 Support tools for creating dedicated programs!

### LabVIEW Drivers

Data acquisition is possible using LabVIEW. LabVIEW drivers can be downloaded from our Web site. (Free of charge)

\*LabVIEW is a registered trademark of National Instruments Corporation in the U.S.A.

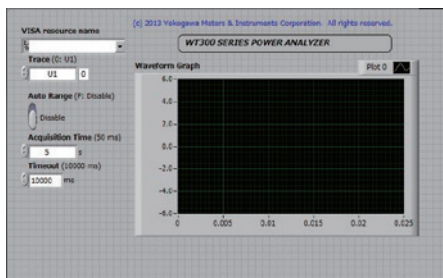

### Programming tool samples

To help users create dedicated programs for their system, some sample programs which support Visual Basic/Visual C++/Visual Basic .NET and Visual C# are prepared\*. The sample programs support communication via USB, GP-IB/RS-232 or Ethernet interfaces and can be downloaded from the web site.

\*Visual Basic, Visual C++, Visual Basic .NET and Visual C# are registered trademarks of Microsoft Corporation in the U.S.A.

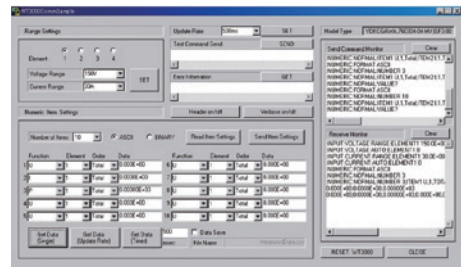

### Comparison between WT210/230 series, WT300 series and WT300E series

	WT300E series	WT300 series	WT210/WT230
Basic power measurement accuracy (50/60 Hz)	0.1% of reading + 0.05% of range	0.1% of reading + 0.1% of range	0.1% of reading + 0.1% of range
Influence of power factor	When power factor (λ) = 0 (S: apparent power) ±0.1% of S for 45 Hz ≤ f ≤ 66 Hz	When power factor (λ) = 0 (S: apparent power) ±0.2% of S for 45 Hz ≤ f ≤ 66 Hz	When power factor (λ) = 0 (S: apparent power) ±0.2% of S for 45 Hz ≤ f ≤ 66 Hz
Frequency bandwidth	DC, 0.1 Hz to 100 kHz (WT310EH DC, 0.1 Hz to 20 kHz)	DC, 0.5 Hz to 100 kHz (WT310HC DC, 0.5 Hz to 20 kHz)	DC, 0.5 Hz to 100 kHz
Direct input Current range	WT310E: 12 ranges/5 mA to 20 A, WT310EH: 6 ranges/1 to 40 A, WT332E/WT333E: 6 ranges/0.5 to 20 A	WT310: 12 ranges/5 mA to 20 A, WT310HC: 6 ranges/1 to 40 A, WT332/WT333: 6 ranges/0.5 to 20 A	WT210: 12 ranges/5 mA to 20 A, WT230-2ch/WT230-3ch: 6 ranges/0.5 to 20 A
External current input	EX1: 2.5/5/10 [V] EX2: 50 m/100 m/200 m/500 m/1/2 [V] (OP.)	EX1: 2.5/5/10 [V] EX2: 50 m/100 m/200 m/500 m/1/2 [V] (OP.)	EX1: 2.5/5/10 [V] EX2: 50 m/100 m/200 m [V] (OP.)
Expansion of effective input range for voltage & current (CF = 6A)	2% to 260%*1	No	No
Expansion of maximum displaying value for voltage & current (CF = 6A)	2% to 280%*2	No	No
Simultaneous measurement of RMS, Voltage MEAN & DC	Yes*3	Yes*3	No
Frequency measurement	2 channels (voltage and current)	2 channels (voltage and current)	selected voltage or current (one)
Number of display item	4 items	4 items	3 items
Sampling rate	Approximately 100 kS/s	Approximately 100 kS/s	Approximately 50 kS/s
Data Update rate	100 m/250 m/500 m/1/2/5/10/20 sec, Auto	100 m/250 m/500 m/1/2/5 sec	100 m/250 m/500 m/1/2/5 sec
Harmonic measurement	Yes (OP, /G5)	Yes (OP, /G5)	Yes (OP, /HRM)
THD calculation maximum order setting	Yes (OP, 1 to 50th)	Yes (OP, 1 to 50th)	No
Auto ranging of integration	Yes	Yes	No
Communication interface	USB	Yes	No
	GP-IB	Yes GP-IB or RS-232	Yes (OP) GP-IB or RS-232C
	RS-232	Yes GP-IB or RS-232	Yes (OP) GP-IB or RS-232C
	Ethernet	Yes (OP)	No
	Modbus/TCP (Ethernet)	Yes (OP, /C7)	No
IEEE standard for GP-IB	IEEE488.2	IEEE488.2	IEEE488.1 and IEEE488.2
Comparator function	Yes	Yes	Yes
Viewer software (setting & data capturing)	Free (included)	Free (included)	Free (download)

\*1: WT310EH input range is 2% to 260% (20 A range only up to 200%)

\*2: WT310EH input range is 2% to 280% (20 A range only up to 220%)

\*3: Simultaneous, mode independent measurement using the WTViewerFreePlus PC software.

\*A command compatible mode for the previous WT200 series is prepared. (IEEE488.2 only)

In that mode, the WT300E series and WT300 series works identically to a WT200 series except for the Store (and recall operation) and the Compare functions.

\*Modbus/TCP communication requires /C7 Ethernet option.

# Basic characteristics

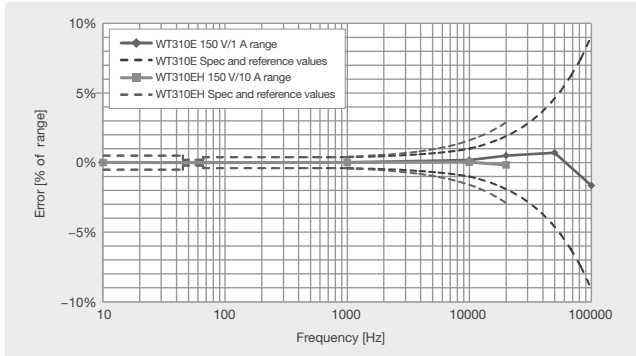

Example of Frequency—power Accuracy Characteristics

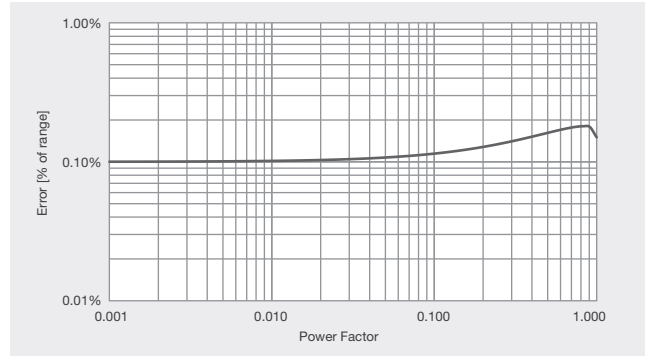

Total power Error with rated range input for an arbitrary power factor (f = 50/60 Hz)

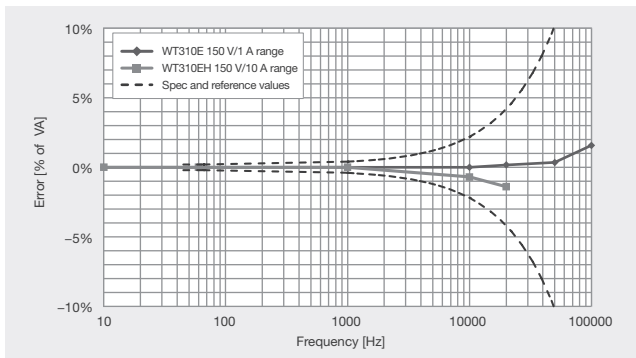

Example of frequency versus power accuracy characteristic (power specification for  $\cos\theta = 0$ )

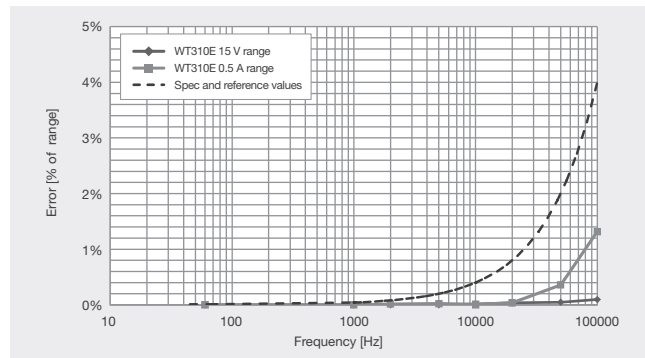

Effect of common mode voltage on reading value (Common Voltage 600 Vrms)

\*Performance of WT332E/WT333E is same as that of WT310E

# Front and rear

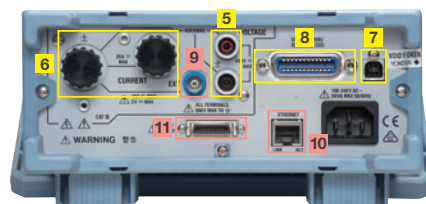

## Key switches

- 1 Function setting
- 2 Element setting
- 3 U/I range setting
- 4 Integration setting

## Standard features

- 5 Voltage input terminals
- 6 Current Input terminals
- 7 USB communication interface
- 8 GP-IB/RS-232

## Optional features

- 9 External current sensor input
- 10 Ethernet
- 11 D/A output connector

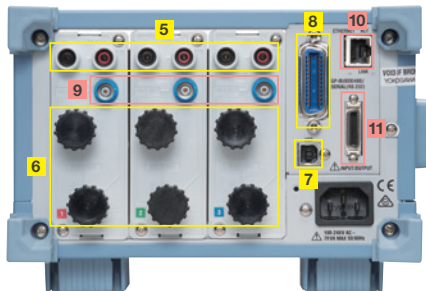

Input	
<b>Input terminal type</b>	
Voltage	Plug-in terminal (safety terminal)
Current	Direct input: Large binding post External current sensor input option: isolated BNC
<b>Input format</b>	
Voltage	Floating input through resistive voltage divider
Current	Floating input through shunt
<b>Measurement range</b>	
Voltage	Crest factor 3: 15 V/30 V/60 V/150 V/300 V/600 V Crest factor 6 or 6A: 7.5 V/15 V/30 V/75 V/150 V/300 V
Current	Direct input Crest factor 3 WT310E: 5 mA/10 mA/20 mA/50 mA/100 mA/200 mA/0.5 A/1 A/2 A/5 A/10 A/20 A WT310EH: 1 A/2 A/5 A/10 A/20 A/40 A WT332E and WT333E: 0.5 A/1 A/2 A/5 A/10 A/20 A Crest factor 6 or 6A WT310E: 2.5 mA/5 mA/10 mA/25 mA/50 mA/100 mA/0.25 A/0.5 A/1 A/2.5 A/5 A/10 A WT310EH: 0.5 A/1 A/2.5 A/5 A/10 A/20 A WT332E and WT333E: 0.25 A/0.5 A/1 A/2.5 A/5 A/10 A External current sensor input (/EX1,/EX2) Crest factor 3 EX1: 2.5 V/5 V/10 V or EX2: 50 mV/100 mV/200 mV/500 mV/1 V/2 V Crest factor 6 or 6A EX1: 1.25 V/2.5 V/5 V or EX2: 25 mV/50 mV/100 mV/250 mV/500 mV/1 V
<b>Input impedance</b>	
Voltage	Input resistance: Approx. 2 MΩ, input capacitance: Approx. 13 pF in parallel with the resistance
Current	Direct input WT310E Crest factor 3: 5 mA/10 mA/20 mA/50 mA/100 mA/200 mA Crest factor 6 or 6A: 2.5 mA/5 mA/10 mA/25 mA/50 mA/100 mA at the above range setting, Input resistance: Approx. 500 mΩ, Input inductance: Approx. 0.1 μH in series with the resistance Crest factor 3: 0.5 A/1 A/2 A/5 A/10 A/20 A Crest factor 6 or 6A: 0.25 A/0.5 A/1 A/2.5 A/5 A/10 A at the above range setting, Input resistance: Approx. 6 mΩ + 10 mΩ (max) *Factory setting Input inductance: Approx. 0.1 μH in series with the resistance WT310EH Crest factor 3: 1 A/2 A/5 A/10 A/20 A/40 A Crest factor 6 or 6A: 0.5 A/1 A/2.5 A/5 A/10 A/20 A Input resistance: Approx. 5 mΩ, input inductance: Approx. 0.1 μH in series with the resistance WT332E/WT333E Crest factor 3: 0.5 A/1 A/2 A/5 A/10 A/20 A Crest factor 6 or 6A: 0.25 A/0.5 A/1 A/2.5 A/5 A/10 A Input resistance: Approx. 6 mΩ, input inductance: Approx. 0.1 μH in series with the resistance External current sensor input (/EX1) Crest factor 3: 2.5 V/5 V/10 V Crest factor 6 or 6A: 1.25 V/2.5 V/5 V Input resistance: Approx. 100 kΩ External current sensor input (/EX2) Crest factor 3: 50 mV/100 mV/200 mV/500 mV/1 V/2 V Crest factor 6 or 6A: 25 mV/50 mV/100 mV/250 mV/500 mV/1 V Input resistance: Approx. 20 kΩ
<b>Instantaneous maximum allowable input (1 period, for 20 ms)</b>	
Voltage	Peak value of 2.8 kV or RMS value of 2.0 kV, whichever is less.
Current	Direct input WT310E Crest factor 3: 5 mA/10 mA/20 mA/50 mA/100 mA/200 mA Crest factor 6 or 6A: 2.5 mA/5 mA/10 mA/25 mA/50 mA/100 mA at the above range setting, Peak value of 150 A or RMS value of 100 A, whichever is less. Crest factor 3: 0.5 A/1 A/2 A/5 A/10 A/20 A Crest factor 6 or 6A: 0.25 A/0.5 A/1 A/2.5 A/5 A/10 A at the above range setting, Peak value of 450 A or RMS value of 300 A, whichever is less. WT310EH Crest factor 3: 1 A/2 A/5 A/10 A/20 A/40 A Crest factor 6 or 6A: 0.5 A/1 A/2.5 A/5 A/10 A/20 A Peak value of 450 A or RMS value of 300 A, whichever is less. WT332E/WT333E Crest factor 3: 0.5 A/1 A/2 A/5 A/10 A/20 A Crest factor 6 or 6A: 0.25 A/0.5 A/1 A/2.5 A/5 A/10 A Peak value of 450 A or RMS value of 300 A, whichever is less. External current sensor input Peak value less than or equal to 10 times of the rated range.
<b>Instantaneous maximum allowable input (for 1 s)</b>	
Voltage	Peak value of 2 kV or RMS value of 1.5 kV, whichever is less
Current	Direct input WT310E Crest factor 3: 5 mA/10 mA/20 mA/50 mA/100 mA/200 mA Crest factor 6 or 6A: 2.5 mA/5 mA/10 mA/25 mA/50 mA/100 mA at the above range setting, Peak value of 30 A or RMS value of 20 A, whichever is less. Crest factor 3: 0.5 A/1 A/2 A/5 A/10 A/20 A Crest factor 6 or 6A: 0.25 A/0.5 A/1 A/2.5 A/5 A/10 A at the above range setting, Peak value of 150 A or RMS value of 40 A, whichever is less.

WT310EH	Crest factor 3: 1 A/2 A/5 A/10 A/20 A/40 A Crest factor 6 or 6A: 0.5 A/1 A/2.5 A/5 A/10 A/20 A Peak value of 150 A or RMS value of 44 A, whichever is less.																																
WT332E/WT333E	Crest factor 3: 0.5 A/1 A/2 A/5 A/10 A/20 A Crest factor 6 or 6A: 0.25 A/0.5 A/1 A/2.5 A/5 A/10 A Peak value of 150 A or RMS value of 40 A, whichever is less.																																
External current sensor input Peak value less than or equal to 10 times of the rated range.																																	
<b>Continuous maximum allowable input</b>																																	
Voltage	Peak value of 1.5 kV or RMS value of 1 kV, whichever is less.																																
Current	Direct input WT310E Crest factor 3: 5 mA/10 mA/20 mA/50 mA/100 mA/200 mA Crest factor 6 or 6A: 2.5 mA/5 mA/10 mA/25 mA/50 mA/100 mA at the above range setting, Peak value of 30 A or RMS value of 20 A, whichever is less. Crest factor 3: 0.5 A/1 A/2 A/5 A/10 A/20 A Crest factor 6 or 6A: 0.25 A/0.5 A/1 A/2.5 A/5 A/10 A at the above range setting, Peak value of 100 A or RMS value of 30 A, whichever is less. WT310EH Crest factor 3: 1 A/2 A/5 A/10 A/20 A/40 A Crest factor 6 or 6A: 0.5 A/1 A/2.5 A/5 A/10 A/20 A Peak value of 100 A or RMS value of 44 A, whichever is less. WT332E/WT333E Crest factor 3: 0.5 A/1 A/2 A/5 A/10 A/20 A Crest factor 6 or 6A: 0.25 A/0.5 A/1 A/2.5 A/5 A/10 A Peak value of 100 A or RMS value of 30 A, whichever is less. External current sensor input Peak value less than or equal to 5 times of the rated range.																																
<b>Continuous maximum common mode voltage (during 50/60 Hz input)</b> 600 Vrms CAT II																																	
<b>Influence of common mode voltage</b>																																	
When 600 Vrms is applied between the input terminal and case with the voltage input terminals shorted, current input terminals open and external current sensor input terminals shorted. Double the following values when the crest factor is set to 6 or 6A.																																	
<ul style="list-style-type: none"> <li>At 50/60 Hz: -80 dB or more (±0.01% of range or less)</li> <li>Up to 100 kHz (reference value): 0.01% of range or more. f is frequency of input signal in kHz.</li> <li>15 V, 30 V, 60 V, 150 V, 300 V, 600 V ranges, 0.5 A, 1 A, 2 A, 5 A, 10 A, 20 A ranges of WT310E/WT332E/WT333E, 1 A, 2 A, 5 A, 10 A, 20 A, 40 A ranges of WT310EH and, external current sensor input (/EX2 Option)  <math display="block">\text{Within } \pm \left\{ \frac{(\text{Maximum rated range})}{(\text{Rated range})} \times 0.001 \times f\% \text{ of range} \right\}</math>                     The maximum rated range is 600 V for the voltage input terminal and 20 A for the current input of WT310E/WT332E/WT333E and 40 A for the current input terminal of WT310EH and 2 V for option /EX2.</li> <li>5 mA, 10 mA, 20 mA, 50 mA, 100 mA and 200 mA ranges of WT310E  <math display="block">\text{Within } \pm \left\{ \frac{(\text{Maximum rated range})}{(\text{Rated range})} \times 0.0002 \times f\% \text{ of range} \right\}</math>                     The Maximum rated range is 20 A.</li> <li>External current sensor input (/EX1 Option) ranges  <math display="block">\text{Within } \pm \left\{ \frac{(\text{Maximum rated range})}{(\text{Rated range})} \times 0.01 \times f\% \text{ of range} \right\}</math>                     The maximum rated range is 10 V</li> </ul>																																	
<b>Line filter</b>	Select OFF or ON (cutoff frequency of 500 Hz).																																
<b>Frequency filter</b>	Select OFF or ON (cutoff frequency of 500 Hz).																																
<b>A/D converter</b>	Simultaneous conversion of voltage and current inputs. Resolution: 16 bits. Maximum conversion rate: Approx. 10 μs.																																
<b>Voltage and Current Accuracy</b>																																	
<b>Accuracy</b>																																	
Requirement	Temperature: 23 ±5°C, Humidity: 30 to 75%RH., Input waveform: Sine wave, Crest factor: 3, Common mode voltage: 0 V Scaling function: OFF, Number of displayed digits: 5 digits Frequency filter: Turn ON to measure voltage or current input of 200 Hz or less After warm-up time has passed After zero-level compensation is done or measurement range is changed.																																
Accuracy (at 12 months) (The accuracy shown below is the sum of reading and range errors.) *f in the read error equation is the input signal frequency in kHz.																																	
	<table border="1"> <thead> <tr> <th></th> <th>WT310E, WT332E/WT333E (Voltage/Current)</th> <th>WT310EH (Voltage, Current EXT sensor input)</th> <th>WT310EH (Current Direct input)</th> </tr> </thead> <tbody> <tr> <td>DC</td> <td>±(0.1% of reading + 0.2% of range)</td> <td>±(0.1% of reading + 0.2% of range)</td> <td>±(0.2% of reading + 0.2% of range)</td> </tr> <tr> <td>0.1 Hz ≤ f &lt; 45 Hz</td> <td>±(0.1% of reading + 0.2% of range)</td> <td>±(0.1% of reading + 0.2% of range)</td> <td>±(0.1% of reading + 0.2% of range)</td> </tr> <tr> <td>45 Hz ≤ f ≤ 66 Hz</td> <td>±(0.1% of reading + 0.05% of range)</td> <td>±(0.1% of reading + 0.05% of range)</td> <td>±(0.1% of reading + 0.05% of range)</td> </tr> <tr> <td>66 Hz &lt; f ≤ 1 kHz</td> <td>±(0.1% of reading + 0.2% of range)</td> <td>±(0.1% of reading + 0.2% of range)</td> <td>±(0.1% of reading + 0.2% of range)</td> </tr> <tr> <td>1 kHz &lt; f ≤ 10 kHz</td> <td>±[(0.07 × f)% of reading + 0.3% of range]</td> <td>±[(0.07 × f)% of reading + 0.3% of range]</td> <td>±[(0.13 × f)% of reading + 0.3% of range]</td> </tr> <tr> <td>10 kHz &lt; f ≤ 20 kHz</td> <td></td> <td></td> <td>±[(0.13 × f)% of reading + 0.5% of range]</td> </tr> <tr> <td>10 kHz &lt; f ≤ 100 kHz</td> <td>±(0.5% of reading + 0.5% of range) ±[(0.04 × (f - 10))% of reading]</td> <td>±(0.5% of reading + 0.5% of range) ±[(0.04 × (f - 10))% of reading]</td> <td></td> </tr> </tbody> </table>		WT310E, WT332E/WT333E (Voltage/Current)	WT310EH (Voltage, Current EXT sensor input)	WT310EH (Current Direct input)	DC	±(0.1% of reading + 0.2% of range)	±(0.1% of reading + 0.2% of range)	±(0.2% of reading + 0.2% of range)	0.1 Hz ≤ f < 45 Hz	±(0.1% of reading + 0.2% of range)	±(0.1% of reading + 0.2% of range)	±(0.1% of reading + 0.2% of range)	45 Hz ≤ f ≤ 66 Hz	±(0.1% of reading + 0.05% of range)	±(0.1% of reading + 0.05% of range)	±(0.1% of reading + 0.05% of range)	66 Hz < f ≤ 1 kHz	±(0.1% of reading + 0.2% of range)	±(0.1% of reading + 0.2% of range)	±(0.1% of reading + 0.2% of range)	1 kHz < f ≤ 10 kHz	±[(0.07 × f)% of reading + 0.3% of range]	±[(0.07 × f)% of reading + 0.3% of range]	±[(0.13 × f)% of reading + 0.3% of range]	10 kHz < f ≤ 20 kHz			±[(0.13 × f)% of reading + 0.5% of range]	10 kHz < f ≤ 100 kHz	±(0.5% of reading + 0.5% of range) ±[(0.04 × (f - 10))% of reading]	±(0.5% of reading + 0.5% of range) ±[(0.04 × (f - 10))% of reading]	
	WT310E, WT332E/WT333E (Voltage/Current)	WT310EH (Voltage, Current EXT sensor input)	WT310EH (Current Direct input)																														
DC	±(0.1% of reading + 0.2% of range)	±(0.1% of reading + 0.2% of range)	±(0.2% of reading + 0.2% of range)																														
0.1 Hz ≤ f < 45 Hz	±(0.1% of reading + 0.2% of range)	±(0.1% of reading + 0.2% of range)	±(0.1% of reading + 0.2% of range)																														
45 Hz ≤ f ≤ 66 Hz	±(0.1% of reading + 0.05% of range)	±(0.1% of reading + 0.05% of range)	±(0.1% of reading + 0.05% of range)																														
66 Hz < f ≤ 1 kHz	±(0.1% of reading + 0.2% of range)	±(0.1% of reading + 0.2% of range)	±(0.1% of reading + 0.2% of range)																														
1 kHz < f ≤ 10 kHz	±[(0.07 × f)% of reading + 0.3% of range]	±[(0.07 × f)% of reading + 0.3% of range]	±[(0.13 × f)% of reading + 0.3% of range]																														
10 kHz < f ≤ 20 kHz			±[(0.13 × f)% of reading + 0.5% of range]																														
10 kHz < f ≤ 100 kHz	±(0.5% of reading + 0.5% of range) ±[(0.04 × (f - 10))% of reading]	±(0.5% of reading + 0.5% of range) ±[(0.04 × (f - 10))% of reading]																															

## Specifications

- Influence of temperature changes after zero-level compensation or range change
  - Add 0.02% of range/°C to the DC voltage accuracy.
  - Add the following value to the DC current accuracies.
    - WT310E (5 mA/10 mA/20 mA/50 mA/100 mA/200 mA ranges): 5 μA/°C
    - WT310E (0.5 A/1 A/2 A/5 A/10 A/20 A ranges) and WT332E/WT333E direct current input: 500 μA/°C
    - WT310EH direct current input: 1 mA/°C
    - External current sensor input (/EX1): 1 mV/°C
    - External current sensor input (/EX2): 50 μV/°C
- Accuracy of the Upk, Ipk and waveform display data.
  - Add the following value to the above accuracy (reference value). The effective input range is within ±300% of range (within ±600% for Crest factor 6 or 6A)
    - Voltage input:  $1.5 \times \sqrt{(15/\text{range})\%}$  of range
    - Direct current input range:
      - WT310E (5 mA/10 mA/20 mA/50 mA/100 mA/200 mA range):  $3 \times \sqrt{(0.005/\text{range})\%}$  of range
      - WT310E (0.5 A/1 A/2 A/5 A/10 A/20 A range) and WT332E/WT333E direct current input:  $3 \times \sqrt{(0.5/\text{range})\%}$  of range
      - WT310EH direct current input:  $3 \times \sqrt{(1/\text{range})\%}$  of range
    - External current sensor input range:
      - /EX1 Option:  $3 \times \sqrt{(2.5/\text{range})\%}$  of range
      - /EX2 Option:  $3 \times \sqrt{(0.05/\text{range})\%}$  of range
- Influence of self-generated heat caused by voltage input
  - Add 0.0000001 × U<sup>2</sup>% of reading to the AC voltage accuracies.
  - Add 0.0000001 × U<sup>2</sup>% of reading + 0.0000001 × U<sup>2</sup>% of range to the DC current accuracies.
  - U is the voltage reading (V).
  - Influence of self-generated heat caused by voltage input lasts until falling the temperature of the input resistor even if voltage input decreases.
- Influence of self-generated heat caused by current input
  - WT310E:
    - Add 0.00013 × I<sup>2</sup>% of reading to the AC current accuracies.
    - Add 0.00013 × I<sup>2</sup>% of reading + 0.004 × I<sup>2</sup> mA (0.5 A/1 A/2 A/5 A/10 A/20 A range) or 0.00013 × I<sup>2</sup>% of reading + 0.00004 × I<sup>2</sup> mA (5 mA/10 mA/20 mA/50 mA/100 mA/200 mA range), to the DC current accuracies.
    - I is the current reading (A).
  - WT310EH:
    - Add 0.00006 × I<sup>2</sup>% of reading to the AC current accuracies.
    - Add 0.00006 × I<sup>2</sup>% of reading + 0.001 × I<sup>2</sup> mA to the DC current accuracies.
    - I is the current reading (A).
  - WT332E/WT333E:
    - Add 0.00013 × I<sup>2</sup>% of reading to the AC current accuracies.
    - Add 0.00013 × I<sup>2</sup>% of reading + 0.002 × I<sup>2</sup> mA to the DC current accuracies.
    - I is the current reading (A).
    - Influence of self-generated heat caused by current input lasts until falling the temperature of the shunt resistor even if current input decreases.
- Accuracy changes caused by data update interval
  - When the data update interval is 100 ms, and Auto, add 0.05% of reading to the 0.1 Hz to 1 kHz accuracy.
- Guaranteed accuracy ranges for frequency, voltage and current (direct input)
  - All accuracy figures for 0.1 Hz to 10 Hz are reference values.
  - The accuracy figures for DC, 10 Hz to 45 Hz, and 400 Hz to 30 kHz when the current exceeds 20 A are reference values.
  - WT310E: The maximum current input is 6 A when the frequency is over 30 kHz to 100 kHz.

### Input range

- 1 to 130% with respect to the rated range of voltage or current. (It displays up to 140%)
  - (Add the reading error × 0.5 to above accuracies for the range of 110% to 130% of the rated range.)
  - \*WT310EH: 40 A range only 1 to 100% (display is 110%)
  - Crest factor 6A: 2 to 260% with respect to the rated range of voltage or current. (It displays up to 280%)
  - \*Crest factor 6A: Except the range up condition of the automatic range and an effective input range, the other operation is equal to crest factor 6.
  - The synchronization source level must meet the frequency measurement input signal level.

### Measurement frequency range

data update interval	Measurement Frequency Range
0.1 s	DC, 20 Hz ≤ f ≤ 100 kHz
0.25 s	DC, 10 Hz ≤ f ≤ 100 kHz
0.5 s	DC, 5 Hz ≤ f ≤ 100 kHz
1 s	DC, 2.0 Hz ≤ f ≤ 100 kHz
2 s	DC, 1.0 Hz ≤ f ≤ 100 kHz
5 s	DC, 0.5 Hz ≤ f ≤ 100 kHz
10 s	DC, 0.2 Hz ≤ f ≤ 100 kHz
20 s	DC, 0.1 Hz ≤ f ≤ 100 kHz
Auto (*)	DC, 0.1 Hz ≤ f ≤ 100 kHz

(\*) Limit of the measurement lower limit frequency by the Timeout setting

Timeout	lower limit frequency
1 s	2.0 Hz
5 s	0.5 Hz
10 s	0.2 Hz
20 s	0.1 Hz

Only for direct current input of WT310EH, the maximum measurement range is 20 kHz.

### When the line filter is turned ON

45 to 66 Hz: Add 0.2% of reading. Less than 45 Hz: Add 0.5% of reading.

### Temperature coefficient

Add: ±0.03% of reading/°C within the range 5 to 18°C or 28 to 40°C.

### Accuracy when the crest factor is set to 6 or 6A

Accuracy obtained by doubling the measurement range error for the accuracy when the crest factor is set to 3.

## WT300E Series

### Active Power Accuracy

#### Accuracy

- Requirements Same as the conditions for voltage and current.
  - Power factor: 1

Accuracy (at 12 months)

(The accuracy shown below is the sum of reading and range errors.)

\*f in the read error equation is the input signal frequency in kHz.

	WT310E/WT310EH/ WT332E/WT333E (Current EXT sensor input)	WT310EH (Current Direct input)
DC	±(0.1% of reading + 0.2% of range)	±(0.3% of reading + 0.2% of range)
0.1 Hz ≤ f < 45 Hz	±(0.3% of reading + 0.2% of range)	±(0.3% of reading + 0.2% of range)
45 Hz ≤ f ≤ 66 Hz	±(0.1% of reading + 0.05% of range)	±(0.1% of reading + 0.05% of range)
66 Hz < f ≤ 1 kHz	±(0.2% of reading + 0.2% of range)	±(0.2% of reading + 0.2% of range)
1 kHz < f ≤ 10 kHz	±(0.1% of reading + 0.3% of range) ±[(0.067 × (f - 1))% of reading]	±((0.13 × f)% of reading + 0.3% of range)
10 kHz < f ≤ 20 kHz		±((0.13 × f)% of reading + 0.5% of range)
10 kHz < f ≤ 100 kHz	±(0.5% of reading + 0.5% of range) ±[(0.09 × (f - 10))% of reading]	

- Influence of temperature changes after zero-level compensation or range change
  - Add the product of the voltage influence and the current influence listed below to the DC power accuracies.
  - DC voltage accuracy: 0.02% of range/°C
  - DC current accuracies
    - WT310E (5 mA/10 mA/20 mA/50 mA/100 mA/200 mA ranges): 5 μA/°C
    - WT310E (0.5 A/1 A/2 A/5 A/10 A/20 A ranges) and WT332E/WT333E direct current input: 500 μA/°C
    - WT310EH direct current input: 1 mA/°C
    - External current sensor input (/EX1): 1 mV/°C
    - External current sensor input (/EX2): 50 μV/°C
- Influence of self-generated heat caused by voltage input
  - Add 0.0000001 × U<sup>2</sup>% of reading to the AC power accuracies.
  - Add 0.0000001 × U<sup>2</sup>% of reading + 0.0000001 × U<sup>2</sup>% of range to the DC power accuracies.
  - U is the voltage reading (V).
  - Influence of self-generated heat caused by voltage input lasts until falling the temperature of the input resistor even if voltage input decreases.
- Influence of self-generated heat caused by current input
  - WT310E:
    - Add 0.00013 × I<sup>2</sup>% of reading to the AC power accuracies.
    - Add 0.00013 × I<sup>2</sup>% of reading + 0.004 × I<sup>2</sup> mA × U (0.5 A/1 A/2 A/5 A/10 A/20 A range) or 0.00013 × I<sup>2</sup>% of reading + 0.00004 × I<sup>2</sup> mA × U (5 mA/10 mA/20 mA/50 mA/100 mA/200 mA range), to the DC power accuracies.
    - I is the current reading (A), U is the voltage reading.
  - WT310EH:
    - Add 0.00006 × I<sup>2</sup>% of reading to the AC power accuracies.
    - Add 0.00006 × I<sup>2</sup>% of reading + 0.001 × I<sup>2</sup> mA × U to the DC power accuracies.
    - I is the current reading (A), U is the voltage reading.
  - WT332E/WT333E:
    - Add 0.00013 × I<sup>2</sup>% of reading to the AC power accuracies.
    - Add 0.00013 × I<sup>2</sup>% of reading + 0.002 × I<sup>2</sup> mA × U to the DC power accuracies.
    - I is the current reading (A), U is the voltage reading.
    - Influence of self-generated heat caused by current input lasts until falling the temperature of the shunt resistor even if current input decreases.
- Accuracy changes caused by data update interval
  - When the data update interval is 100 ms, add 0.05% of reading to 0.1 Hz to 1 kHz accuracy.
- Guaranteed accuracy ranges for frequency, voltage and current (direct input)
  - All accuracy figures for 0.1 Hz to 10 Hz are reference values.
  - The accuracy figures for DC, 10 Hz to 45 Hz, and 400 Hz to 30 kHz when the current exceeds 20 A are reference values.
  - WT310E: The maximum current input is 6 A when the frequency is over 30 kHz to 100 kHz.

### Influence of power factor

- When power factor (λ) = 0 (S: apparent power)
  - ±0.1% of S for 45 Hz ≤ f ≤ 66 Hz.
  - ±((0.1 + 0.15 × f)% of S) for up to 100 kHz as reference data.
  - f is frequency of input signal in kHz.
- When 0 < λ < 1 (φ: phase angle of the voltage and current)
  - (power reading) × [(power reading error %) + (power range error %) × (power range/indicated apparent power value) + (tan φ × (influence when λ = 0)%)]
  - Value of "influence % when λ = 0" will be changed by frequency according to above expressions.

### When the line filter is turned ON

45 to 66 Hz: Add 0.3% of reading. Less than 45 Hz: Add 1% of reading.

### Temperature coefficient

Same as the temperature coefficient for voltage and current.

### Accuracy when the crest factor is set to 6 or 6A

Accuracy obtained by doubling the measurement range error for the accuracy when the crest factor is set to 3.

### Accuracy of apparent power S

Voltage accuracy + current accuracy

### Accuracy of reactive power Q

Accuracy of apparent power +  $(\sqrt{(1.0004 - \lambda^2)} - \sqrt{(1 - \lambda^2)}) \times 100\%$  of range

### Accuracy of power Factor λ

±[(λ - λ / 1.0002) + |cos φ - cos{φ + sin<sup>-1</sup> (influence from the power factor when λ = 0%/100)}|] ± 1 digit  
when voltage and current are at the measurement range rated input

### Accuracy of phase difference φ

±[φ - cos<sup>-1</sup> (λ / 1.0002)] + sin<sup>-1</sup> [(influence from the power factor when λ = 0%/100)] deg ± 1 digit  
when voltage and current are at the measurement range rated input



**Voltage, Current, and Active Power Measurements**

Measurement method	Digital sampling method
Crest factor	3 or 6 (6A)

**Wiring system**  
 WT310E, WT310EH (One element model)  
 Single-phase, two-wire (1P2W)  
 WT332E (Two element model)  
 Select from; single-phase, three-wire (1P3W); or three-phase, three-wire (3P3W)  
 WT333E (Three element model)  
 Select from; single-phase, three-wire (1P3W); three-phase, three-wire (3P3W); three-phase, four-wire (3P4W); or three-voltage, three-current (3V3A).

**Range select**  
 Select manual or auto ranging.

**Auto range**  
 Range Up  
 The range is upped when any of the following conditions is met.  
 • Crest factor 3: Urms or Irms exceeds 130% of the currently set measurement range.  
 Upk, Ipk value of the input signal exceeds 300% of the currently set measurement range.  
 • Crest factor 6: Urms or Irms exceeds 130% of the currently set measurement range.  
 Upk, Ipk value of the input signal exceeds 600% of the currently set measurement range.  
 • Crest factor 6A: Urms or Irms exceeds 260% of the currently set measurement range.  
 Upk, Ipk value of the input signal exceeds 600% of the currently set measurement range.  
 On the WT332E/WT333E, when any of those input elements meets the above condition, the range is upped the next time the measured value is updated.

Range down  
 The range is downed when all of the following conditions are met.  
 • Crest factor 3: Urms or Irms is less than or equal to 30% of the measurement range.  
 Urms or Irms is less than or equal to 125% of the next lower measurement range.  
 Upk, Ipk value of the input signal exceeds 300% of the currently set measurement range.  
 • Crest factor 6 or 6A: Urms or Irms is less than or equal to 30% of the measurement range.  
 Urms or Irms is less than or equal to 125% of the next lower measurement range.  
 Upk, Ipk value of the input signal exceeds 600% of the currently set measurement range.  
 On the WT332E/WT333E, when all of the input elements meet the above condition, the range is downed the next time the measured value is updated.

**Display mode Switching**  
 Select RMS (the true RMS value of voltage and current),  
 VOLTAGE MEAN (the rectified mean value calibrated to the RMS value of the voltage and the true RMS value of the current), DC (simple average of voltage and current).

**Measurement synchronization source**  
 Select voltage, current, or the entire period of the data update interval for the signal used to achieve synchronization during measurement.  
 In the case of Auto Update Rate, select the voltage or current from the equipped element.

**Line filter**  
 Select OFF or ON (cutoff frequency at 500 Hz).

**Peak measurement**  
 Measures the peak (max, min) value of voltage, current or power from the instantaneous voltage, instantaneous current or instantaneous power that is sampled.

**Zero-level compensation**  
 Removes the internal offset of the WT310E/WT310EH/WT332E/WT333E.

**Frequency Measurement**

**Measured item**  
 Voltage and current frequencies applied to one selected input element can be measured.  
 WT332E (two element model)  
 Select voltage (U1)/ current (I1) of input element1 or voltage (U3)/ current (I3) of input element3.  
 WT333E (three element model)  
 Select voltage (U1)/ current (I1) of input element1, voltage (U2)/ current (I2) of input element2 or voltage (U3)/ current (I3) of input element3.

**Method**  
 Reciprocal method

**Frequency measuring range**  
 Varies depending on the data update interval (see description given later) as follows.

Data Update Interval	Measurement Range
0.1 s	20 Hz ≤ f ≤ 100 kHz
0.25 s	10 Hz ≤ f ≤ 100 kHz
0.5 s	5 Hz ≤ f ≤ 100 kHz
1 s	2.0 Hz ≤ f ≤ 100 kHz
2 s	1.0 Hz ≤ f ≤ 100 kHz
5 s	0.5 Hz ≤ f ≤ 100 kHz
10 s	0.2 Hz ≤ f ≤ 100 kHz
20 s	0.1 Hz ≤ f ≤ 100 kHz
Auto (*)	0.1 Hz ≤ f ≤ 100 kHz

(\*) Limit of the measurement lower limit frequency by the Timeout setting

Timeout	lower limit frequency
1 s	2.0 Hz
5 s	0.5 Hz
10 s	0.2 Hz
20 s	0.1 Hz

Only for the direct current input of WT310EH, the maximum measurement range is 20 kHz.

**Measurement range**  
 Auto switching among six types: 1 Hz, 10 Hz, 100 Hz, 1 kHz, 10 kHz, and 100 kHz.

**Frequency filter**  
 Select OFF or ON (cutoff frequency of 500 Hz).

**Accuracy**  
 Requirements  
 When the input signal level is 30% or more of the measurement range If the crest factor is set to 3. (60% or more if the crest factor is set to 6 or 6A)  
 • Frequency filter is ON when measuring voltage or current of 200 Hz or less.  
 Accuracy: ± (0.06% of reading)

**Computation**

Computing equation of apparent power (S), reactive power (Q), power factor (λ), and phase angle (φ)  
 i: input element number

	Single-Phase, Three-Wire (1P3W)	Three-Phase, Three-Wire (3P3W)	Three-Voltage, Three-Current Method (3V3A)	Three-Phase, Four-Wire (3P4W)
$U_{\Sigma}$ [V]	(U1+U3)/2		(U1+U2+U3)/3	
$I_{\Sigma}$ [A]	(I1+I3)/2		(I1+I2+I3)/3	
$P_{\Sigma}$ [W]	P1+P3			P1+P2+P3
$S_{\Sigma}$ [VA]	$S_i = U_i \times I_i$	S1+S3	$\frac{\sqrt{3}}{2}(S1+S3)$	$\frac{\sqrt{3}}{3}(S1+S2+S3)$
$Q_{\Sigma}$ [var]	$Q_i = \sqrt{S_i^2 - P_i^2}$	Q1+Q3		Q1+Q2+Q3
$\lambda_{\Sigma}$	$\lambda_i = P_i/S_i$	$\frac{P_{\Sigma}}{S_{\Sigma}}$		
$\phi$ [°]	$\phi_i = \cos^{-1}\left(\frac{P_i}{S_i}\right)$	$\cos^{-1}\left(\frac{P_{\Sigma}}{S_{\Sigma}}\right)$		

- On the WT310E/WT310EH/WT332E/WT333E, S, Q, λ, and φ are derived through the computation of the measured values of voltage, current, and active power. Therefore, for distorted signal input, the value obtained on the WT310E/WT310EH/WT332E/WT333E may differ from that obtained on other instruments that use a different method.
- If the voltage or current is less than 0.5% (less than or equal to 1% if the crest factor is set to 6 or 6A) of the rated range, zero is displayed for S or Q, and error is displayed for λ and φ.
- For Q [var], when the current leads the voltage, the Q value is displayed as a negative value; when the current lags the voltage, the Q value is displayed as a positive value. The value of QΣ may be negative, because it is calculated from the Q of each element with the signs included.

**Lead and lag detection (Phase angle φ's D (lead) and G (lag))**  
 The lead and lag of the voltage and current inputs can be detected correctly for the following:  
 • Sine waves  
 • When the measured value is 50% or more (100% or more when the crest factor is 6 or 6A) of the measurement range  
 • Frequency: 20 Hz to 2 kHz (WT310EH: to 1 kHz)  
 • Phase difference: ±(5° to 175°)

**Scaling**  
 Set the current sensor transformation ratio, VT ratio, CT ratio, and power factor when applying the external current sensor, VT, or CT output to the instrument.  
 • Significant digits: Selected automatically according to significant digits in the voltage and current ranges.  
 • Selectable range: 0.001 to 9999

**Averaging**  
 Select the method from the following two types.  
 • Exponential averaging method  
 • Moving average method  
 Select the attenuation constant for exponential averaging; select the sample number from 8, 16, 32, and 64 for moving average.

**Efficiency**  
 Computation of efficiency is possible on the WT332E/WT333E.

**Crest factor**  
 Computes the crest factor (peak value/RMS value) of voltage and current.

**Four arithmetic operation**  
 Six types of four arithmetic operations possible (A+B, A-B, AxB, A/B, A²/B, and A/B²)

**Average active power during integration**  
 Computes the average active power within the integrated period.

**Integration**

**Mode**  
 Select manual integration mode, standard integration mode, or repetitive integration mode.  
 \*Auto Update Rate cannot use the Integration mode.

**Timer**  
 Automatically stop integration by setting a timer.  
 Selectable range: 0 hours 00 minutes 00 seconds to 10000 hours 00 minutes 00 seconds (Set automatically to manual integration mode for 0 hours 00 minutes 00 seconds)

**Count overflow**  
 WP: 999999 MWh/-99999 MWh, q: 999999 MAh/-99999 MAh  
 Holds the elapsed integration time and integration value and stops integration when the elapsed time of integration reaches the maximum integration time of 10000 hours or when the integrated value reaches the maximum or minimum displayable integration value (999999M or -999999M).

**Accuracy**  
 ±(Power accuracy (or current accuracy) + 0.1% of reading) (fixed range)  
 \*In the case of auto range: The measurement is not carried out during a range change. The first measurement data after the range change is added for the Period which measurement was not carried out.

**Range setting**  
 Auto range or fixed range is available for Integration  
 For details on range switching, see section of "Voltage, Current, and Active Power Measurements".

## Specifications

### Valid Frequency Ranges for Integration

Active power DC to 45 kHz

Current When the measurement mode is RMS:  
DC, lower limit frequency determined by the data update interval to 45 kHz  
When the measurement mode is VOLTAGE MEAN:  
DC, lower limit frequency determined by the data update interval to 45 kHz  
When the measurement mode is DC:  
DC to 45 kHz

Timer accuracy  $\pm 0.02\%$

### Remote control

Start, stop and reset operations are available using an external remote signal.  
(applies to products with the /DA4 or /DA12 option)

### Harmonic Measurement (/G5 Option)

Measured item  
All installed elements.

Method  
PLL synchronization method

Frequency range  
Fundamental frequency of the PLL source is in the range of 10 Hz to 1.2 kHz.

PLL source  
Select voltage or current of each input element.

- Input level  
50% or more of the rated measurement range when the crest factor is 3.  
100% or more of the rated measurement range when the crest factor is 6 or 6A.
- The frequency filter must be turned on when the fundamental frequency is less than or equal to 200 Hz.

FFT data length  
1024

Window function  
Rectangular

### Sample rate, window width, and upper limit of analysis

Fundamental Frequency	Sample rate	Window Width	Upper Limit of Analysis orders
10 Hz to 75 Hz	$f \times 1024$	1	50
75 Hz to 150 Hz	$f \times 512$	2	32
150 Hz to 300 Hz	$f \times 256$	4	16
300 Hz to 600 Hz	$f \times 128$	8	8
600 Hz to 1200 Hz	$f \times 64$	16	4

f is the input fundamental frequency.

\*The upper limit of analysis orders can be decreased.

### Accuracy

(The accuracy shown below is the sum of reading and range errors.)  
When Line Filter is OFF

#### WT310E/WT332E/WT333E

Frequency	Voltage	Current	Power
10 Hz $\leq$ f < 45 Hz	$\pm(0.15\%$ of reading + 0.35% of range)	$\pm(0.15\%$ of reading + 0.35% of range)	$\pm(0.35\%$ of reading + 0.50% of range)
45 Hz $\leq$ f $\leq$ 440 Hz	$\pm(0.15\%$ of reading + 0.35% of range)	$\pm(0.15\%$ of reading + 0.35% of range)	$\pm(0.25\%$ of reading + 0.50% of range)
440 Hz < f $\leq$ 1 kHz	$\pm(0.20\%$ of reading + 0.35% of range)	$\pm(0.20\%$ of reading + 0.35% of range)	$\pm(0.40\%$ of reading + 0.50% of range)
1 kHz < f $\leq$ 2.5 kHz	$\pm(0.80\%$ of reading + 0.45% of range)	$\pm(0.80\%$ of reading + 0.45% of range)	$\pm(1.56\%$ of reading + 0.60% of range)
2.5 kHz < f $\leq$ 5 kHz	$\pm(3.05\%$ of reading + 0.45% of range)	$\pm(3.05\%$ of reading + 0.45% of range)	$\pm(5.77\%$ of reading + 0.60% of range)

#### WT310EH

Frequency	Voltage	Current	Power
10 Hz $\leq$ f < 45 Hz	$\pm(0.15\%$ of reading + 0.35% of range)	$\pm(0.15\%$ of reading + 0.35% of range)	$\pm(0.35\%$ of reading + 0.50% of range)
45 Hz $\leq$ f $\leq$ 440 Hz	$\pm(0.15\%$ of reading + 0.35% of range)	$\pm(0.15\%$ of reading + 0.35% of range)	$\pm(0.25\%$ of reading + 0.50% of range)
440 Hz < f $\leq$ 1 kHz	$\pm(0.20\%$ of reading + 0.35% of range)	$\pm(0.20\%$ of reading + 0.35% of range)	$\pm(0.40\%$ of reading + 0.50% of range)
1 kHz < f $\leq$ 2.5 kHz	$\pm(0.80\%$ of reading + 0.45% of range)	$\pm(0.95\%$ of reading + 0.45% of range)	$\pm(1.68\%$ of reading + 0.60% of range)
2.5 kHz < f $\leq$ 5 kHz	$\pm(3.05\%$ of reading + 0.45% of range)	$\pm(3.35\%$ of reading + 0.45% of range)	$\pm(6.05\%$ of reading + 0.60% of range)

The items listed below apply to all of the tables.

- When the crest factor is set to 3.
- When  $\lambda$  (the power factor) is 1.
- Power figures that exceed 1.2 kHz are reference values.
- For the direct current range, add 10  $\mu$ A to the current accuracy and (10  $\mu$ A/direct current range)  $\times$  100% of range to the power accuracy.
- For the external current sensor range, add 100  $\mu$ V to the current accuracy and (100  $\mu$ V/external current sensor range rating)  $\times$  100% of range to the power accuracy.
- For  $n^{\text{th}}$  harmonics component input, add  $((n/(n+1))/50)\%$  of the  $n^{\text{th}}$  harmonics reading to the  $n+m^{\text{th}}$  harmonics and  $n-m^{\text{th}}$  harmonics of the voltage and current, and add  $((n/(n+1))/25)\%$  of the  $n^{\text{th}}$  harmonics reading to the  $n+m^{\text{th}}$  harmonics and  $n-m^{\text{th}}$  harmonics of the power.
- Add  $(n/500)\%$  of reading to the  $n^{\text{th}}$  component of the voltage and current, and add  $(n/250)\%$  of reading to the  $n^{\text{th}}$  component of the power.
- The accuracy when the crest factor is 6 or 6A is the same as the accuracy when the crest factor is 3 after doubling the measurement range.
- The guaranteed accuracy ranges for frequency, voltage, and current, are the same as the guaranteed ranges for ordinary measurement.

## WT300E Series

If the amplitude of the high frequency component is large, influence of approximately 1% may appear in certain harmonics.  
Because the influence depends on the level of the frequency component, if the frequency component is small with respect to the range rating, the influence is also negligible.

### Display

Display type 7-segment LED

Simultaneous display 4 items

### Maximum display (display range)

During normal measurement			
Displayed item	When the number of displayed digits is 5	When the number of displayed digits is 4	
U, I, P, S*, Q*	99999	9999	
$\lambda^*$	1.0000 to -1.0000	1.000 to -1.000	
$\phi^*$	G180.0 to d180.0	G180.0 to d180.0	
fU*, fI*	99999	9999	
WP, WP $\pm$ , q, q $\pm$	When the unit is MWh or MAh 999999 (-99999 for negative watt hour and ampere hour.)	When the unit is other than MWh or MAh 99999	
TIME	Elapsed integration time	Display A indication	Display resolution
	0 to 99 hours 59 minutes 59 seconds	0.00.00 to 99.59.59	1 s
	100 hours to 9999 hours 59 minutes 59 seconds	100.00 to 9999.59	1 minute
10000 hours	10000	1 hour	
Efficiency (WT332E/WT333E)	100.00 to 999.99 (%)	100.0 to 999.9 (%)	
Crest factor	99999	9999	
Four arithmetic operation	99999	9999	
Average active power	99999	9999	
Voltage peak	99999	9999	
Current peak	99999	9999	
Power Peak	99999	9999	

\*The computation accuracy (the value calculated from the measured value) is one-half the display resolution.

### During harmonic measurement

Displayed item	When the number of displayed digits is 5	When the number of displayed digits is 4
U, I, P	99999	9999
$\lambda$	1.0000 to -1.0000	1.000 to -1.000
Uhdf, Ihdf, Phdf	0.000 to 99.999 to 100.00 to 999.99%	0.00 to 99.99 to 100.0 to 999.9%
Uthd, Ithd	0.000 to 99.999 to 100.00 to 999.99%	0.00 to 99.99 to 100.0 to 999.9%
$\phi$ U, $\phi$ I	Phase angle of the 1st fundamental current with respect to the 1st fundamental voltage. G180.0 to d180.0	G180.0 to d180.0
	Phase angle of the 2nd harmonics and higher harmonic of voltage with respect to the 1st fundamental voltage -180.0 to 180.0	-180.0 to 180.0
	Phase angle of the 2nd harmonics and higher harmonics of current with respect to the 1st fundamental current -180.0 to 180.0	-180.0 to 180.0

Unit symbols m, k, M, V, A, W, VA, var,  $^\circ$ , Hz, h $\pm$ , TIME, %

Number of displayed digits Select 5 or 4 digits

Data update interval Select 0.1 s, 0.25 s, 0.5 s, 1 s, 2 s, 5 s, 10 s, 20 s or Auto.  
In the case of Auto Update Rate cannot use the Integration function and store the measurement data.

Response time At maximum, 2 times the data update rate  
(The time it takes to reach the accuracy of the final value when the displayed value changed from 0 to 100% or 100 to 0% of the rated range)

Auto range monitor The indicator illuminates when the input signal meets the conditions for auto range switching.

Overrange display Overrange "- oL- -" is displayed for the following conditions.  
Crest factor 3 or 6  
When the measured value exceeds 140% of the rated range  
\*WT310EH: 40 A range  
When the measured value exceeds 110% of the rated range  
Crest factor 6A  
When the measured value exceeds two times of the above setting.

Hold Holds the displayed value.

Single update Updates the displayed value once each time the SINGLE key is pressed during Hold.

MAX hold Holds the maximum displayed value of U, I, P, S, Q, U $\pm$ pk, I $\pm$ pk and P $\pm$ pk.

Internal memory	
Measured data	Recall the stored measurement data by a communication command. Store interval Data update interval or in the range of 1 s to 99 hrs 59 min 59 s. There is no backup function of stored measurement data In the case of Auto Update Rate cannot store the measurement data.
Setup information	Saves/Loads four patterns of setup information.

External Current Sensor Input (/EX1 and /EX2 options)	
Allows input of voltage output type current sensor signal. For detailed input specifications, see "Input." Measurement range of the /EX1 option Crest factor 3: 2.5 V, 5 V, 10 V Crest factor 6 or 6A: 1.25 V, 2.5 V, 5 V	
Measurement range of the /EX2 option Crest factor 3: 50 mV, 100 mV, 200 mV, 500 mV, 1 V, 2 V Crest factor 6 or 6A: 25 mV, 50 mV, 100 mV, 250 mV, 500 mV, 1 V	

D/A Output (/DA4, /DA12 Options)	
Output voltage	±5 V FS (approx. ±7.5 V maximum) against each rated value.
Number of output channels	4 outputs for products with the /DA4; 12 outputs for products with the /DA12 option
Output items	Set for each channel. U, I, P, S, Q, λ, φ, f, U <sub>p</sub> , I <sub>p</sub> , Upk, Wp, Wp±, q, q± and MATH
Accuracy	±(accuracy of each measurement item + 0.2% of FS)(FS = 5 V)
D/A conversion resolution	16 bits
Minimum load	100 kΩ
Update Interval	Same as the data update interval. In the case of Auto Update Rate, update interval is equal to signal interval. More than 100ms.
Temperature coefficient	±0.05%/°C of FS

Remote Control Input/Output Signal (/DA4, /DA12 Options)	
Remote control input signal	EXT HOLD, EXT TRIG, EXT START, EXT STOP, EXT RESET
Remote control output signal	INTEG BUSY
I/O level	TTL
I/O logic format	Negative logic, falling edge

GP-IB Interface (Standard on -C1)	
Usable devices	National Instruments Corporation <ul style="list-style-type: none"> <li>• PCI-GPIB or PCI-GPIB+, PCIe-GPIB or PCIe-GPIB+</li> <li>• PCMCIA-GPIB or PCMCIA-GPIB+ (not support on Windows Vista or Windows 7)</li> <li>• GPIB-USB-HS Use driver NI-488.2M Ver. 2.8.1 or later.</li> </ul>
Electrical and mechanical	Complies with IEEE Std 488-1978 (JIS C 1901-1987)

Serial (RS-232) Interface (Standard on -C2)	
Connector type	D-Sub 9-pin (plug)
Electrical specifications	Complies with EIA-574 (EIA-232 (RS-232) standard for 9-pin)
Baud rate	Select from 1200, 2400, 4800, 9600, 19200, 38400 or 57600 bps.

USB PC Interface	
Number of ports	1
Connector	Type B connector (receptacle)
Electrical and Mechanical specifications	Complies with USB Rev. 2.0
Supported transfer modes	HS (High Speed; 480 Mbps) and FS (Full Speed; 12 Mbps)
Supported protocols	USBTMC-USB488 (USB Test and Measurement Class Ver. 1.0)
PC system requirements	A PC with a USB port, running the English or Japanese version of Windows 8 (32 bit/64 bit), Windows 7 (32 bit/64 bit), Windows Vista (32 bit/64 bit) Dedicated driver will be supplied from Yokogawa home page

Ethernet Interface (/C7 Options)	
Ports	1
Connector type	RJ-45 connector
Electrical and Mechanical specifications	Complies with IEEE802.3
Transmission system	Ethernet (100BASE-TX, 10BASE-T)
Transmission rate	100 Mbps max.
Communication protocol	TCP/IP
Supported services	DHCP, remote control (VXI-11, Modbus/TCP)

General Specifications	
Warm-up time	Approx. 30 minutes
Operating environment	Temperature: 5°C to 40°C Humidity: 20%RH to 80%RH (No condensation) Elevation: 2000 m or less
Installation location	Indoors
Storage environment	Temperature: -25°C to 60°C Humidity: 20%RH to 80%RH (No condensation)

Rated supply voltage	100 VAC to 240 VAC
Permitted supply range voltage	90 VAC to 264 VAC
Rated supply frequency	50/60 Hz
Permitted supply voltage frequency range	48 Hz to 63 Hz
Maximum power Consumption	WT310E, WT310EH: 50 VA, WT332E/WT333E: 70 VA
External dimensions (excluding protrusions.)	WT310E, WT310EH: Approx. 213 (W) × 88 (H) × 379 (D) mm WT332E/WT333E: Approx. 213 (W) × 132 (H) × 379 (D) mm
Weight	WT310E, WT310EH: Approx. 3 kg WT332E/WT333E: Approx. 5 kg
Battery backup	Setup parameters are backed up with a lithium battery.
Safety standard*1	Compliant standard EN61010-1, EN61010-2-030 Installation category (overvoltage category) CAT II*2 Measurement Category CAT II*3 Pollution degree 2*4
Emission*1	Compliant standard EN61326-1 Class A EN55011 Class A, Group1 EN61000-3-2 EN61000-3-3 EMC Regulatory Arrangement in Australia and New Zealand EN55011 Class A, Group 1 Korea Electromagnetic Conformity Standard This product is a Class A (for industrial environment) product. Operation of this product in a residential area may cause radio interference in which case the user will be required to correct the interference
Cable conditions	<ul style="list-style-type: none"> <li>• Serial (RS-232) interface connector: Use shielded serial cables*5</li> <li>• GP-IB interface connector: Use shielded GP-IB cables*5</li> <li>• USB port (PC): Use a shielded USB cable*5</li> <li>• Ethernet port: Use a category 5 or better Ethernet cable (STP)*6</li> <li>• D/A output terminal: Use shielded cables*5</li> </ul> Connecting cables may cause radio interference in which case the user is required to correct the interference.
Immunity*1	Compliant standard EN61326-1 Table 2 (for industrial locations) Influence in the immunity environment Measurement input: Within ±30% of range (Within ±60% of range when the crest factor is 6 or 6A) D/A output: Within ±20% of FS FS = 5V
Cable conditions	Same as the cable conditions for emission above.

\*1 Applies to products with CE marks. For information on other products, contact your nearest YOKOGAWA dealer.  
 \*2 The overvoltage category (installation category) is a value used to define the transient overvoltage condition and includes the rated impedance withstand voltage. CAT II applies to electrical equipment that is powered through a fixed installation, such as a wall outlet wired to a distribution board.  
 \*3 This instrument is measurement category II product. Do not use it for Measurement Categories III, and IV. Measurement category O applies to measurement of other circuits that are not directly connected to a main power supply. Measurement category II applies to electrical equipment that is powered through a fixed installation, such as a wall outlet wired to a distribution board, and to measurement performed on such wiring. Measurement category III applies to measurement of facility circuits, such as distribution boards and circuit breakers. Measurement category IV applies to measurement of power source circuits, such as entrance cables to buildings and cable systems, for low-voltage installations.  
 \*4 Pollution Degree applies to the degree of adhesion of a solid, liquid, or gas that deteriorates withstand voltage or surface resistivity. Pollution Degree 2 applies to normal indoor atmospheres (with only non-conductive pollution).  
 \*5 Use cables of length 3 m or less.  
 \*6 Use cables of length 30 m or less.

**Exterior View**

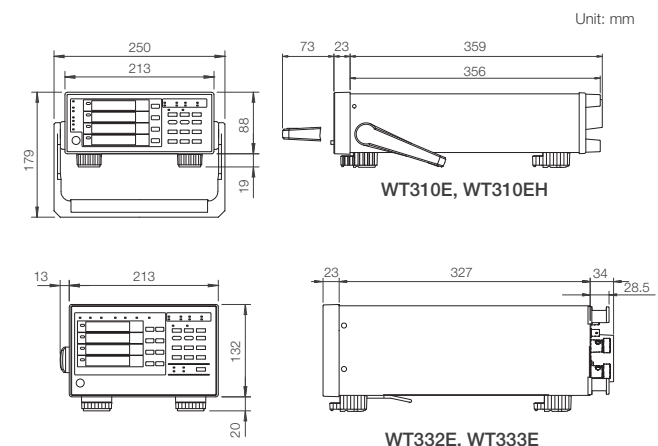

## Model and Suffix code

Model	Suffix Code	Description	
WT310E		1 Input element model	
WT310EH		1 Input element /High current model	
Communication Interface *USB is standard	-C1	select GP- IB	
	-C2	one RS- 232	
	Power Cord	-D	UL, CSA standard, PSE compliant
		-F	VDE standard
		-R	AS standard
		-Q	BS standard
		-H	GB standard
		-N	NBR standard
		-T	Taiwanese standard
		Optional function	/C7
/EX1	External sensor input 2.5 V/5 V/10 V		
/EX2	External sensor input 50 mV/100 mV/200 mV/500 mV/1 V/2 V		
/G5	Harmonics Measurement		
/DA4	D/A- output (4 CH)		
WT332E		2 Input elements model	
WT333E		3 Input elements model	
Communication Interface *USB is standard	-C1	select GP- IB	
	-C2	one RS- 232	
	Power Cord	-D	UL, CSA standard, PSE compliant
		-F	VDE standard
		-R	AS standard
		-Q	BS standard
		-H	GB standard
		-N	NBR standard
		-T	Taiwanese standard
		Optional function	/C7
/EX1	External sensor input 2.5 V/5 V/10 V		
/EX2	External sensor input 50 mV/100 mV/200 mV/500 mV/1 V/2 V		
/G5	Harmonics Measurement		
/DA12	D/A- output (12 CH)		

### Standard accessories

Power cord (1 set), Rubber foot (1 set), Current input protective cover (each 1 set), Start up guide (1 set), Connector (provided only with /DA4 or /DA12, each 1 set), Safety terminal adapter 758931(provided two adapters in a set times input element number), CD (1 piece, included the startup guide, user guide, instruction manual and the communication manual by PDF data, and Viewer Software)

\*1 Only one of these can be selected at a time.

## Rack Mount

Model	Name	Description
751533-E2	Rack mounting kit	For WT310E/WT310EH EIA single mount
751533-J2	Rack mounting kit	For WT310E/WT310EH JIS single mount
751534-E2	Rack mounting kit	For WT310E/WT310EH EIA dual mount
751534-J2	Rack mounting kit	For WT310E/WT310EH JIS dual mount
751533-E3	Rack mounting kit	For WT332E/WT333E EIA single mount
751533-J3	Rack mounting kit	For WT332E/WT333E JIS single mount
751534-E3	Rack mounting kit	For WT332E/WT333E EIA dual mount
751534-J3	Rack mounting kit	For WT332E/WT333E JIS dual mount

Ask Yokogawa for information on rack mounts in which WT310E/WT310EH and WT332E/WT333E are combined.

This is a Class A instrument based on Emission standards EN61326-1 and EN55011, and is designed for an industrial environment. Operation of this equipment in a residential area may cause radio interference, in which case users will be responsible for any interference which they cause.

■ Any company's names and product names mentioned in this document are trade names, trademarks or registered trademarks of their respective companies.

### NOTICE

- Before operating the product, read the user's manual thoroughly for proper and safe operation.

## AC/DC Current Sensor



### CT60/CT200/CT1000/ CT2000A

Current Output

#### AC/DC Current Sensors

- DC to 800 kHz/60 Apeak, DC to 500 kHz/200 Apeak, DC to 300 kHz/1000 Apeak, DC to 40 kHz/2000 Arms (3000 Apeak)
- Wide dynamic range -2000 A to 0 A to +2000 A (DC)/2000 Arms (AC)
- Wide measurement frequency range: DC and up to 800 kHz
- High-precision fundamental accuracy:  $\pm(0.05\%$  of reading + 30  $\mu$ A)
- $\pm 15$  V DC power supply, connector, and load resistor required.

For detailed information, see Current Sensors & Accessories Catalog Bulletin CT1000-00E.

## Clamp on Probe



### 751552

#### Current Clamp on Probe AC 1000 Arms (1400 Apeak)

Current Output

- Measurement frequency range: 30 Hz to 5 kHz
  - Basic accuracy: 0.3% of reading
  - Maximum allowed input: AC 1000 Arms, max 1400 Apk (AC)
  - Current output type: 1 mA/A
- A separately sold fork terminal adapter set (758921), measurement leads (758917), etc. are required for connection to WT300E. For detailed information, see Power Meter Accessory Catalog Bulletin CT1000-00E.

## Accessories

Model	Name	Description
758917	Measurement lead	0.75 m safety terminal cable with 2 leads (red and black) in a set
758922	Small alligator clip adapter	Safety terminal-alligator clip adapter, containing 2 pieces (red and black) in a set
758929	Large alligator clip adapter	Safety terminal-alligator clip adapter, containing 2 pieces (red and black) in a set
758921	Fork terminal adapter	Safety terminal-fork terminal adapter, containing 2 pieces (red and black) in a set
758924	Conversion adapter	BNC-binding post adapter
758923 <sup>*1</sup>	Safety terminal adapter	Spring clamp type 2 adapters (red and black) in a set
758931 <sup>*1</sup>	Safety terminal adapter	Screw-in type 2 adapters (red and black) in a set
B9284LK <sup>*2</sup>	External Sensor Cable	For connection the external input of the WT300E to current sensor. Length: 0.5 m
705926	Connection Cable	26-pin cable for options DA4 and DA12

⚠ Due to the nature of this product, it is possible to touch its metal parts. Therefore, there is a risk of electric shock, so the product must be used with caution.

\*1 Wire diameter of cables that can connect to the adapter

758923 Core wire diameter: 2.5 mm or less, covering diameter: 5.0 mm or less

758931 Core wire diameter: 1.8 mm or less, covering diameter: 3.9 mm or less

\*2 The coax cable is simply cut on the current sensor side. Preparation by the user is required.

## Yokogawa's Approach to Preserving the Global Environment

- Yokogawa's electrical products are developed and produced in facilities that have received ISO14001 approval.
- In order to protect the global environment, Yokogawa's electrical products are designed in accordance with Yokogawa's Environmentally Friendly Product Design Guidelines and Product Design Assessment Criteria.

# YOKOGAWA

## YOKOGAWA TEST & MEASUREMENT CORPORATION

Global Sales Dept. /Phone: +81-422-52-6237 E-mail: tm@cs.jp.yokogawa.com  
Facsimile: +81-422-52-6462

## YOKOGAWA CORPORATION OF AMERICA

### YOKOGAWA EUROPE B.V.

### YOKOGAWA TEST & MEASUREMENT (SHANGHAI) CO., LTD.

### YOKOGAWA ELECTRIC KOREA CO., LTD.

### YOKOGAWA ENGINEERING ASIA PTE. LTD.

### YOKOGAWA INDIA LTD.

### YOKOGAWA ELECTRIC CIS LTD.

### YOKOGAWA AMERICA DO SUL LTDA.

### YOKOGAWA MIDDLE EAST & AFRICA B.S.C(c)

Phone: +1-800-888-6400

Phone: +31-88-4641429

Phone: +86-21-6239-6363

Phone: +82-2-2628-3810

Phone: +65-6241-9933

Phone: +91-80-4158-6396

Phone: +7-495-737-78-68

Phone: +55-11-3513-1300

Phone: +973-17-358100

E-mail: tmi@us.yokogawa.com

E-mail: tmi@nl.yokogawa.com

E-mail: tmi@cs.cn.yokogawa.com

E-mail: TMI@kr.yokogawa.com

E-mail: TMI@sg.yokogawa.com

E-mail: tmi@in.yokogawa.com

E-mail: info@ru.yokogawa.com

E-mail: tm@br.yokogawa.com

E-mail: help.ymatmi@bh.yokogawa.com

Facsimile: +86-21-6880-4987

Facsimile: +82-2-2628-3899

Facsimile: +65-6241-9919

Facsimile: +91-80-2852-1442

Facsimile: +7-495-737-78-69

Facsimile: +973-17-336100

<https://tmi.yokogawa.com/>

YMI-KS-MI-SE07

The contents in this catalog is as of April 2019. Subject to change without notice.

Copyright © 2015, Yokogawa Test & Measurement Corporation

[Ed: 03/b]

Printed in Japan, 903(KP)